

SONY®

2-659-812-11(1)

Digital Video Camera Recorder
HANDYCAM®

Operating Guide

***DCR-HC23E/HC24E/
HC26E/HC35E***

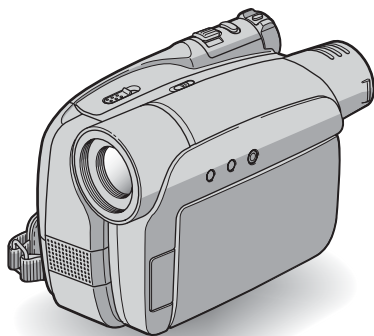

Getting Started **8**



Recording/
Playback **20**

Using the Menu **36**

Dubbing/Editing **51**

Using a Computer **58**

Troubleshooting **68**

Additional Information **83**

Mini **DV** Digital
Video
Cassette

InfoLITHIUM™ **P**
SERIES

Read this first

Before operating the unit, please read this manual thoroughly, and retain it for future reference.

WARNING

To reduce fire or shock hazard, do not expose the unit to rain or moisture.



CAUTION

Replace the battery with the specified type only. Otherwise, fire or injury may result.

FOR CUSTOMERS IN THE UNITED KINGDOM

NOTICE ON THE SUPPLIED AC ADAPTOR

A moulded plug complying with BS1363 is fitted to this equipment for your safety and convenience.

Should the fuse in the plug supplied need to be replaced, a fuse of the same rating as the supplied one and approved by ASTA or BSI to BS 1362, (i.e., marked with  or  mark) must be used.

If the plug supplied with this equipment has a detachable fuse cover, be sure to attach the fuse cover after you change the fuse. Never use the plug without the fuse cover. If you should lose the fuse cover, please contact your nearest Sony service station.

FOR CUSTOMERS IN EUROPE

ATTENTION

The electromagnetic fields at the specific frequencies may influence the picture and sound of this camcorder.

This product has been tested and found compliant with the limits set out in the EMC Directive for using connection cables shorter than 3 meters (9.8 feet).

Notice

If static electricity or electromagnetism causes data transfer to discontinue midway (fail), restart the application or disconnect and connect the communication cable (USB, etc.) again.



Disposal of Old Electrical & Electronic Equipment (Applicable in the European Union and other European countries with separate collection systems)

This symbol on the product or on its packaging indicates that this product shall not be treated as household waste. Instead it shall be handed over to the applicable collection point for the recycling of electrical and electronic equipment. By ensuring this product is disposed of correctly, you will help prevent potential negative consequences for the environment and human health, which could otherwise be caused by inappropriate waste handling of this product. The recycling of materials will help to conserve natural resources. For more detailed information about recycling of this product, please contact your local Civic Office, your household waste disposal service or the shop where you purchased the product. Applicable Accessories: Remote Commander (DCR-HC24E/HC35E)

Notes on use

Your camcorder is supplied with two kinds of operation guides.

- “Operating Guide” (This manual)
- “First Step Guide” for connecting the camcorder to a computer and using the supplied software (stored on the supplied CD-ROM)

Types of cassette you can use in your camcorder

- You can use mini DV cassettes marked with **Mini DV**. Mini DV cassettes with Cassette Memory are incompatible (p. 83).

Using the camcorder

- Do not hold the camcorder by the following parts.



Viewfinder

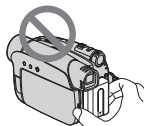

Battery pack

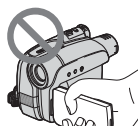

LCD panel

- The camcorder is not dustproof, dripproof or waterproof. See “Maintenance and precautions” (p. 87).
- Before connecting your camcorder to another device with a USB or i.LINK cable, be sure to insert the connector plug the correct way, and not forcibly to avoid damaging the terminal, or cause a malfunction of your camcorder.
- For DCR-HC35E:
Disconnect the AC Adaptor from the Handycam Station holding both the Handycam Station and the DC plug.
- For DCR-HC35E:
Be sure to slide the POWER switch to OFF(CHG) when you insert the camcorder into the Handycam Station or remove the camcorder from it.

About menu items, LCD panel, viewfinder, and lens

- A menu item that is grayed out is not available under the current recording or playback conditions.
- The LCD screen and the viewfinder are manufactured using extremely high-precision technology, so over 99.99% of the pixels are operational for effective use. However, there may be some tiny black points and/or bright points (white, red, blue, or green in color) that appear constantly on the LCD screen and the viewfinder. These points are normal results of the manufacturing process and do not affect the recording in any way.

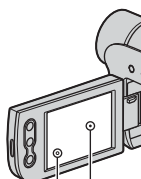

Black point

White, red, blue
or green point

- Exposing the LCD screen, the viewfinder, or the lens to direct sunlight for long periods of time may cause malfunctions.
- Do not aim at the sun. Doing so might cause your camcorder to malfunction. Take pictures of the sun only in low light conditions, such as at dusk.

On recording

- Before starting to record, test the recording function to make sure the picture and sound are recorded without any problems.

Read this first (Continued)

- Compensation for the contents of recordings cannot be provided, even if recording or playback is not possible due to a malfunction of the camcorder, storage media, etc.
- TV color systems differ depending on the countries/regions. To view your recordings on a TV, you need a PAL system-based TV.
- Television programs, films, video tapes, and other materials may be copyrighted. Unauthorized recording of such materials may be contrary to the copyright laws.

About this manual

- The images of the LCD screen and the viewfinder used in this manual for illustration purposes are captured using a digital still camera, and therefore may appear different.
- The on-screen displays in each local language are used for illustrating the operating procedures. Change the screen language before using your camcorder if necessary (p. 49).
- The illustrations used on this manual are based on the model DCR-HC35E. The model name is indicated on the bottom of your camcorder.
- Design and specifications of recording media and accessories are subject to change without notice.

About the Carl Zeiss lens

Your camcorder is equipped with a Carl Zeiss lens, which was developed jointly by Carl Zeiss, in Germany, and Sony Corporation, and produces superior images. It adopts the MTF* measurement system for video cameras and offers a quality typical of a Carl Zeiss lens.

* MTF stands for Modulation Transfer Function. The number value indicates the amount of light from a subject coming into the lens.

Table of Contents

Read this first	2
-----------------------	---

Getting Started

Step 1: Checking supplied items	8
Step 2: Charging the battery pack	9
Step 3: Turning the power on and holding your camcorder firmly	14
Step 4: Adjusting the LCD panel and viewfinder	15
Step 5: Using the touch panel	16
Changing the language setting	16
Checking the screen indicators (Display guide)	16
Step 6: Setting the date and time	18
Step 7: Inserting a Cassette	19



Recording/Playback

Easy Recording/Playback (Easy Handycam)	20
Recording	22
Playback	23
Functions used for recording/playback, etc.	24
Recording	
To use zoom	
To record in dark places (NightShot plus)	
To adjust the exposure for backlit subjects (BACK LIGHT)	
To adjust the focus for an off center subject (SPOT FOCUS)	
To fix the exposure for the selected subject (Flexible spot meter)	
To record in mirror mode	
To use a tripod	
To use a Shoulder Belt	
Playback	
To play back the images with added special effects (Picture effect)	
Recording/playback	
To check the remaining battery (Battery Info)	
To turn off the operation confirmation beep (BEEP)	
To initialize the settings (RESET)	
Other part names and functions	
Indicators displayed during recording/playback	26
Searching for the starting point	28
Searching for the last scene of the most recent recording (END SEARCH)	28
Searching manually (EDIT SEARCH)	28
Reviewing the most recently recorded scenes (Rec review)	29

Remote Commander (DCR-HC24E/HC35E)	30
Searching quickly for a desired scene (Zero set memory)	30
Searching for a scene by date of recording (Date search)	31
Searching for a still image (Photo search)	31
Playing back still images in sequence (Photo scan)	31
Playing the picture on a TV	33

Using the Menu

<i>Using the menu items</i>	36
Operation button items	38
Menu items	43
 MANUAL SET menu	44
– PROGRAM AE/P EFFECT, etc.	
 CAMERA SET menu	45
– D ZOOM/WIDE SEL/STEADYSHOT, etc.	
 PLAYER SET /  VCR SET menu	47
– HiFi SOUND/AUDIO MIX	
 LCD/VF SET menu	47
– LCD B.L./LCD COLOR/VF B.L., etc	
 TAPE SET menu	48
– REC MODE/AUDIO MODE/REMAIN	
 SETUP MENU menu	49
– CLOCK SET/USB STREAM/LANGUAGE, etc.	
 OTHERS menu	50
– WORLD TIME/BEEP, etc.	

Dubbing/Editing

Dubbing to VCR/DVD device, etc.	51
Recording pictures from a TV or VCR/DVD device, etc. (DCR-HC26E/HC35E)	54
Dubbing sound to a recorded tape	55
Jacks to connect external devices	57

Using a Computer

Before referring to the “First Step Guide” on your computer	58
Installing the software and “First Step Guide” on a computer	60
Viewing “First Step Guide”	64
Creating a DVD (Direct Access to “Click to DVD”)	65

Troubleshooting

Troubleshooting	68
Warning indicators and messages	80

Additional Information

Using your camcorder abroad	83
Usable cassette tapes	83
About the “InfoLITHIUM” battery pack	84
About i.LINK	86
Maintenance and precautions	87
Specifications	90
Index	94

Step 1: Checking supplied items

Make sure that you have following items supplied with your camcorder. The number in the parentheses indicates the number of that item supplied.

- The cassette tape is not supplied. See page 3, 83 for compatible cassettes for your camcorder.

AC Adaptor (1) (p. 9)

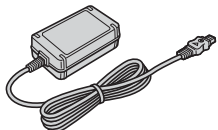

Mains lead (1) (p. 9)



Handycam Station (1)
(DCR-HC35E) (p. 10)

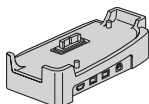

Wireless Remote Commander (1)
(DCR-HC24E/HC35E) (p. 30)



A button-type lithium battery is already installed.

A/V connecting cable (1) (p. 33, 52)



USB cable (1)
(DCR-HC24E/HC35E) (p. 57, 58)

- A USB cable is not supplied with the DCR-HC23E/HC26E models. If necessary, buy a USB 2.0 cable (Type A to Type B-mini.). A Sony product is recommended.

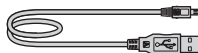

Lens cap (1) (p. 14, 22)



- To attach the lens cap

Attach the lens cap to the metal fittings of the grip belt, as illustrated below, using the strap.

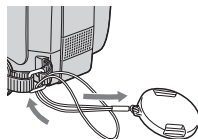

Rechargeable battery pack NP-FP30 (1)
(p. 9, 84)

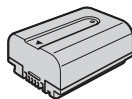

CD-ROM "Picture Package Ver.1.5.1" (1)
(p. 58)

21-pin adaptor (1) (DCR-HC35E) (p. 34)

For the models with the  mark printed on their bottom surfaces only.

Operating Guide (This manual) (1)

Step 2: Charging the battery pack

You can charge the “InfoLITHIUM” battery pack (P series) (p. 84) after attaching it to your camcorder.

For DCR-HC35E:

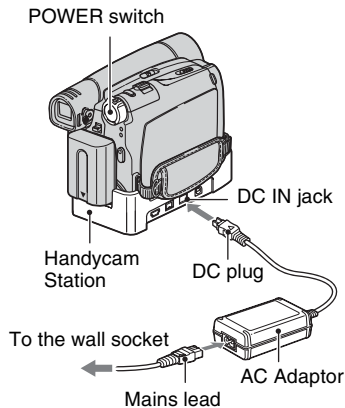

For DCR-HC23E/HC24E/HC26E:

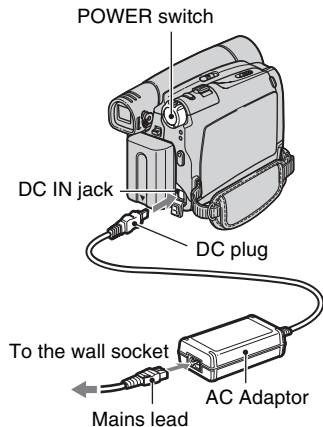

- 1 Align the terminals of the battery pack and your camcorder ①, then attach the battery pack and click it into place ②.

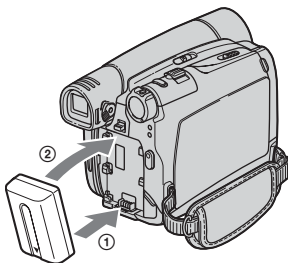

- 2 Slide the POWER switch in the direction of the arrow to OFF(CHG) (The default setting).

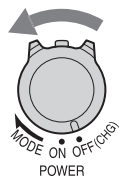

Step2: Charging the battery pack (Continued)

- 3** Connect the AC Adaptor to the DC IN jack on the Handycam Station for the DCR-HC35E or on your camcorder for the DCR-HC23E/HC24E/HC26E.

For DCR-HC35E:

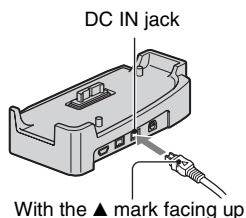

For DCR-HC23E/HC24E/HC26E:

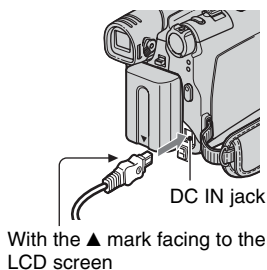

- 4** For DCR-HC35E:
Connect the mains lead to the AC Adaptor and the wall socket. Insert the camcorder into the Handycam Station securely, all the way to the bottom.

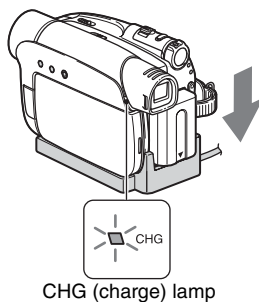

The CHG (charge) lamp lights up and charging starts.

- When inserting the camcorder into the Handycam Station, close the DC IN jack cover.

For DCR-HC23E/HC24E/HC26E:
Connect the mains lead to the AC Adaptor and the wall socket.

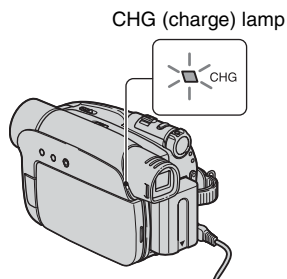

The CHG (charge) lamp lights up and charging starts.

5 The CHG (charge) lamp turns off when the battery is fully charged. Disconnect the AC Adaptor from the DC IN jack.

For DCR-HC35E:

Disconnect the AC Adaptor from the DC IN jack holding both the Handycam Station and the DC plug.

For DCR-HC35E:
To charge the battery pack using only the AC Adaptor

Slide the POWER switch to OFF(CHG). Then connect the AC Adaptor directly to the DC IN jack on the camcorder.

- You can operate your camcorder connected to a power source such as a wall socket as shown in the illustration. The battery pack will not lose its charge in this case.

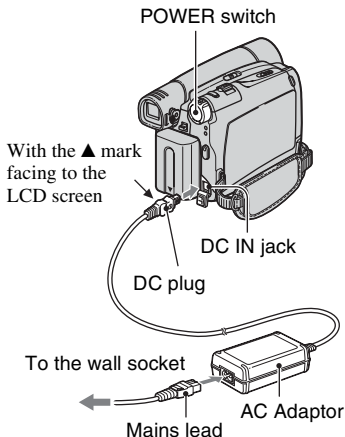

For DCR-HC35E:
To remove your camcorder from the Handycam Station

Turn off the power, then remove the camcorder from the Handycam Station holding both your camcorder and the Handycam Station.

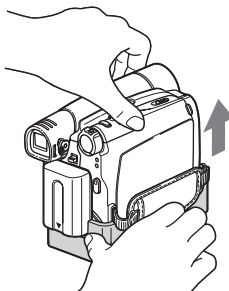

For DCR-HC23E/HC24E/HC26E:
To use an outside power source

You can operate your camcorder using the power from the wall socket by making the same connections as you do when charging the battery pack. The battery pack will not lose its charge in this case.

To remove the battery pack

- ① Slide the POWER switch to OFF(CHG). Hold down the ▼ BATT(battery) release lever with one hand.

Step2: Charging the battery pack (Continued)

- ② Remove the battery in the direction of the arrow with the other hand.

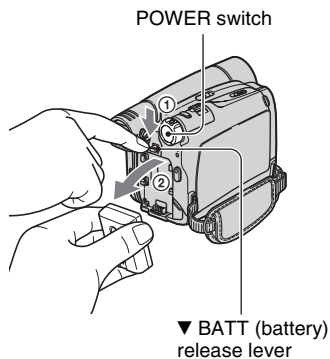

When storing the battery pack

Fully discharge the battery before storing it for an extended period (p. 85).

Charging time

Approximate time (min.) required when you fully charge a fully discharged battery pack.

Battery pack	Charging time
NP-FP30 (supplied)	115
NP-FP50	125
NP-FP70	155
NP-FP71	170
NP-FP90	220

Recording time

Approximate time (min.) available when you use a fully charged battery pack.

Battery pack	Continuous recording time	Typical recording time*
NP-FP30 (supplied)	95	45
	110	55
NP-FP50	135	65
	160	80
NP-FP70	280	140
	330	165
NP-FP71	330	165
	395	195
NP-FP90	500	250
	580	290

- All times measured under the following conditions:
 - Top: Recording with LCD screen.
 - Bottom: Recording with viewfinder while the LCD panel closed.
- * Typical recording time shows the time when you repeat recording start/stop, turning the power on/off and zooming.

Playing time

Approximate time (min.) available when you use a fully charged battery pack.

Battery pack	LCD panel opened	LCD panel closed
NP-FP30 (supplied)	105	135
	150	190
NP-FP50	150	190
NP-FP70	310	395
NP-FP71	370	465
NP-FP90	550	705

On the battery pack

- Before changing the battery pack, slide the POWER switch to OFF(CHG).
- The CHG (charge) lamp flashes during charging, or the Battery Info (p. 25) will not be correctly displayed under the following conditions.
 - The battery pack is not attached correctly.
 - The battery pack is damaged.
 - The battery pack is worn-out. (For Battery Info only.)
- The power will not be supplied from the battery as long as the AC Adaptor is connected to the DC IN jack of your camcorder or the Handycam Station supplied with the DCR-HC35E, even when the mains lead is disconnected from the wall socket.

On the charging/recording/playback time

- Times measured with the camcorder at 25 °C (77 °F). (10 to 30 °C (50 °F to 86 °F) is recommended.)
- The recording and playback time will be shorter when you use your camcorder in low temperatures.
- The recording and playback time will be shorter depending on the conditions under which you use your camcorder.

On the AC Adaptor

- Use the nearby wall socket when using the AC Adaptor. Disconnect the AC Adaptor from the wall socket immediately if any malfunction occurs while using your camcorder.
- Do not use the AC Adaptor placed in a narrow space, such as between a wall and furniture.
- Do not short-circuit the DC plug of the AC Adaptor or battery terminal with any metallic objects. This may cause a malfunction.

PRECAUTION

- Even if your camcorder is turned off, AC power (mains) is still supplied to it while connected to the wall socket via the AC Adaptor.

Step 3: Turning the power on and holding your camcorder firmly

To record or play back, slide the POWER switch repeatedly to turn on the respective lamp.

When using it for the first time, the [CLOCK SET] screen appears (p. 18).

POWER switch Lens cap

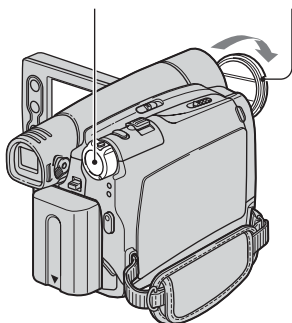

1 Remove the lens cap by pressing both knobs on the sides of the cap.

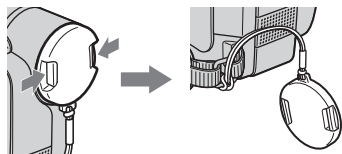

2 Slide the POWER switch repeatedly in the direction of the arrow to turn on the respective lamp.

If the POWER switch is set to OFF(CHG), slide it while pressing the green button.

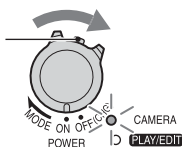

Lamps that light up

CAMERA: To record on a tape.

PLAY/EDIT: To play or edit pictures.

- After you have set the date and time ([CLOCK SET], p. 18), the next time you turn on the power of your camcorder, the current date and time will be displayed on the LCD screen for a few seconds.

3 Hold the camcorder correctly.

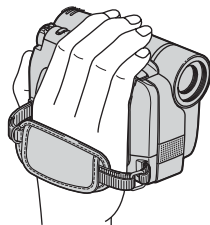

4 Ensure a good grip, then fasten the grip belt.

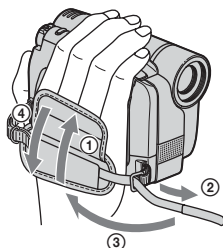

To turn off the power

- ① Slide the POWER switch to OFF(CHG).
- ② Attach the lens cap.

- At the time of purchase, the power will be set to turn off automatically if you leave your camcorder without any operation attempted for approximately 5 minutes, to save battery power ([A.SHUT OFF], p. 50).

Step 4: Adjusting the LCD panel and viewfinder

The LCD panel

Open the LCD panel 90 degrees to the camcorder (①), then rotate it to the best angle to record or play (②).

180 degrees
(max.)

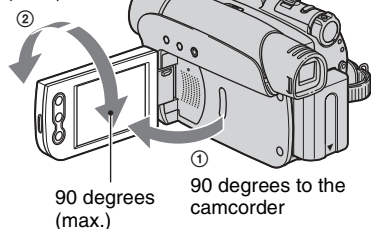

- Do not press the buttons on the LCD frame accidentally when you open or adjust the LCD panel.
- If you rotate the LCD panel 180 degrees to the lens side, you can close the LCD panel with the LCD screen facing out. This is convenient during playback operations.
- See [LCD BRT] (p. 41) to adjust the brightness of the LCD screen.

The viewfinder

You can view pictures using the viewfinder to avoid wearing down the battery, or when the picture seen on the LCD screen is poor.

Viewfinder

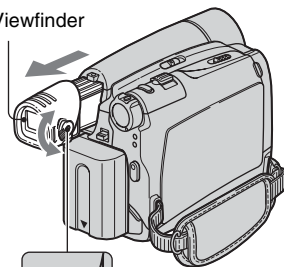

Viewfinder lens
adjustment lever

Move it until the picture is
clear.

- You can adjust the brightness of the viewfinder backlight by selecting [LCD/VF SET] - [VF B.L.] (p. 47).
- You can adjust the [FADER] and the [EXPOSURE] setting using the viewfinder (p. 39).

Step 5: Using the touch panel

You can play back recorded pictures (p. 23), or change the settings (p. 36) using the touch panel.

Place your hand on the rear side of the LCD panel to support it. Then, touch the buttons displayed on the screen.

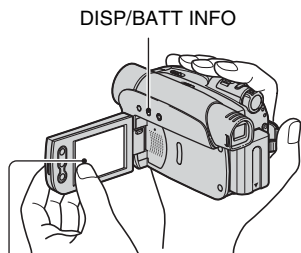



Touch the button on the LCD screen.

- Perform the same actions as explained above when you press the buttons on the LCD frame.
- Be careful not to press buttons on the LCD frame accidentally while using the touch panel.
- If the buttons on the touch panel do not work correctly, adjust the LCD screen (CALIBRATION) (p. 88).
- Dots in lines may appear on the LCD screen, but this is not a malfunction. These dots are not recorded.

To hide the screen indicators

Press DISP/BATT INFO to toggle the screen indicators (such as time code) on or off.

Changing the language setting

You can change the on-screen displays to show messages in a specified language. Select the screen language in [ LANGUAGE] on the [ (SETUP MENU)] (p. 36, 49).

Checking the screen indicators (Display guide)

You can easily check the meaning of each indicator (p. 27) that appears on the LCD screen.

1 Touch [FN] .

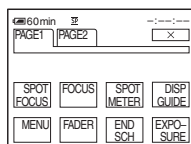

2 Touch [DISP GUIDE].

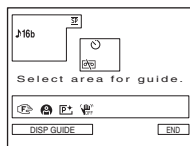

The indicators vary depending on the settings.

3 Touch the area including the indicator that you want to check.

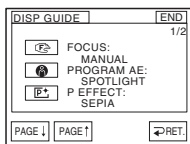

The meanings of the indicators in the area are listed on the screen. If you cannot find the indicator you want to check, touch [PAGE ↓]/[PAGE ↑] to toggle.

When you touch [← RET.], the screen returns to the area selecting display.

To finish the operation

Touch [END].

Step 6: Setting the date and time

Set the date and time when using this camcorder for the first time. If you do not set the date and time, the [CLOCK SET] screen appears every time you turn on your camcorder or change the POWER switch position.

- If you do not use your camcorder for **about 3 months**, the built-in rechargeable battery gets discharged and the date and time settings may be cleared from the memory. In that case, charge the rechargeable battery and then set the date and time again (p. 89).

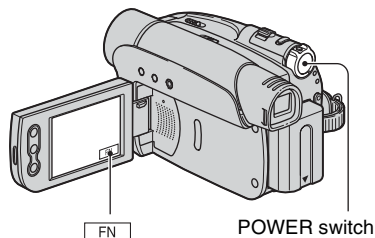

Skip to step 4 when you set the clock for the first time.

1 Touch → [MENU].

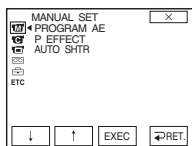

2 Select (SETUP MENU) with / , then touch [EXEC].

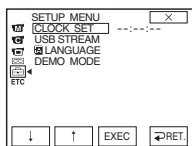

3 Select [CLOCK SET] with / , then touch [EXEC].

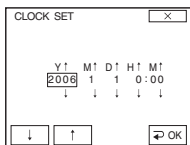

4 Set [Y] (year) with / , then touch .

You can set any year up to the year 2079.

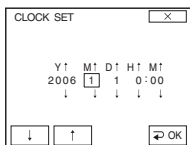

5 Set [M] (month), [D] (day), [H] (hour) and [M] (minute), then touch .

The clock starts.

- The date and time are not displayed while recording, but they are automatically recorded as the date and time data to display while playing back by selecting [DATA CODE] to [DATE/TIME] (p. 41).

Step 7: Inserting a Cassette

You can use mini DV ^{Mini} DV cassettes only (p. 83).

- The recordable time varies depending on [REC MODE] (p. 48).

-
- 1** Slide and hold the  OPEN/EJECT lever in the direction of the arrow and open the lid.

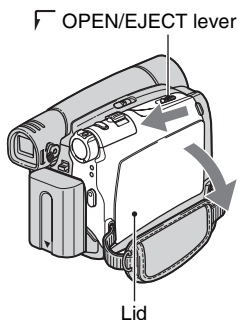

The cassette compartment automatically comes out and opens up.

-
- 2** Insert a cassette with its window facing outwards, then press

PUSH.

Push the center of the back of the cassette lightly.

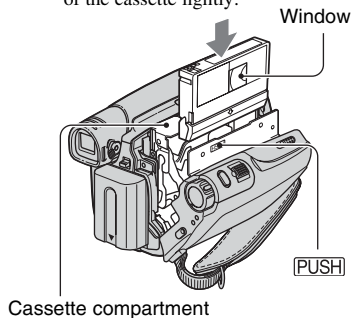

The cassette compartment automatically slides back in.

- Do not force the cassette compartment closed by pressing the portion marked **DO NOT PUSH** while it is sliding in. It may cause a malfunction.

-
- 3** Close the lid.

To eject the cassette

Open the lid following the same procedure as described in Step 1 and remove the cassette.

- For DCR-HC35E:
Do not insert/eject the cassette while your camcorder is on the Handycam Station. This may cause a malfunction.



Easy Recording/Playback (Easy Handycam)

With this Easy Handycam operation, most of the camera settings are automatically optimally adjusted, which frees you from detailed adjustments. The screen font size increases for easy viewing.

Remove the lens cap (p. 14).

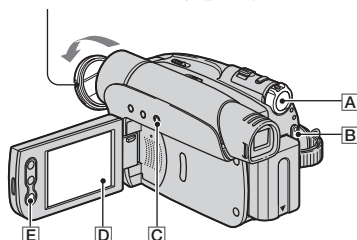

Recording

- Slide the **POWER** switch **A** in the direction of the arrow repeatedly to turn on the **CAMERA** lamp.

If the **POWER** switch **A** is set to OFF(CHG), slide it while pressing the green button.

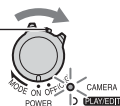

- Press **EASY** **C**.



EASY appears on the screen **D**.

- Press **REC START/STOP** **B** to start recording.*

The indicator **A** changes [STBY] to [REC].
To stop recording, press **B** again.

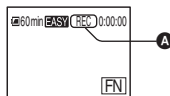

* Movies are recorded in SP (Standard Play) mode on a cassette. You can also start/stop recording by pressing the button **E** on the LCD frame.

Playback

Slide the **POWER** switch **[A]** in the direction of the arrow repeatedly to turn on the **PLAY/EDIT** lamp. Touch the buttons on the screen **[D]** as follows.

If the **POWER** switch is set to **OFF(CHG)**, slide it while pressing the green button.

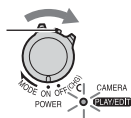

Touch **[◀◀C]**, then touch **[▶▶]** to start playback.

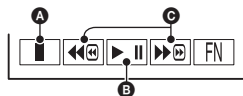

- A** Stop
- B** Play/Pause toggles as you touch it
- C** Rewind/Fast forward

■ To cancel Easy Handycam operation

Press **EASY** **[C]** again. **EASY** disappears from the screen **[D]**.

■ Adjustable menu settings during Easy Handycam operation

Touch **[FN]** and **[MENU]** to display adjustable menu settings. See page 36 for details on setting.

- Almost all the settings return to the default setting automatically (p. 43).
- Cancel Easy Handycam operation if you want to add any effects or settings to the images. Almost all the settings are returned to the previous situation.

■ Unavailable buttons during Easy Handycam

During Easy Handycam operation, the following buttons are unavailable, since the items are set automatically. [Invalid during Easy Handycam operation.] appears if operations not available during Easy Handycam are attempted.

- **BACK LIGHT** button (p. 24)
- **PHOTO** button (p. 22)

Recording

Lens cap

Remove the lens cap by pressing both knobs on the sides of the cap

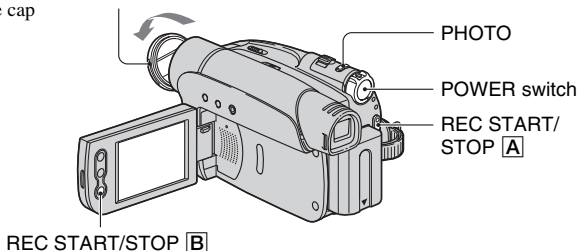

1 Slide the **POWER** switch in the direction of the arrow repeatedly to turn on the **CAMERA** lamp.

If the **POWER** switch is set to **OFF(CHG)**, slide it while pressing the green button.

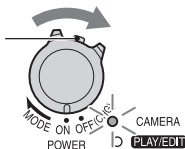

2 Start recording.

Movies

Press **REC START/STOP** [A] (or [B]).

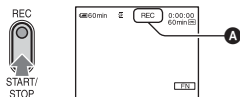

The indicator (A) changes [STBY] to [REC].

Still images

Press and hold **PHOTO** lightly to check the image (A), then press it fully (B).

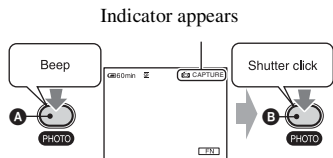

A shutter sound is heard, and the image is recorded with sound for 7 seconds.

To stop movie recording

Press **REC START/STOP** again.

- appears when the tape photo recording does not work.

Playback

- 1 Slide the **POWER** switch in the direction of the arrow repeatedly to turn on the **PLAY/EDIT** lamp.

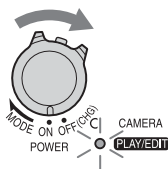

- 2 Start playing back.

Touch to rewind the tape to the desired point, then touch to start playback.

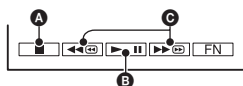

- A Stop
- B Play/Pause toggles as you touch it
 - Playback automatically stops if pause is engaged for more than 3 minutes.
- C Rewind/Fast forward

To adjust the volume

Touch → [PAGE1] → [VOL], then / to adjust the volume.

To search for a scene during playback

Touch and hold / during playback (Picture Search), or / while fast forwarding or rewinding the tape (Skip Scan).

- You can play back in various modes ([V SPD PLAY], p. 42).

Functions used for recording/playback, etc.

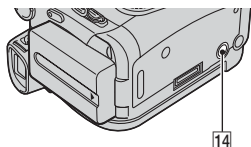
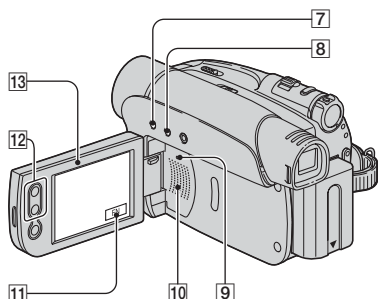
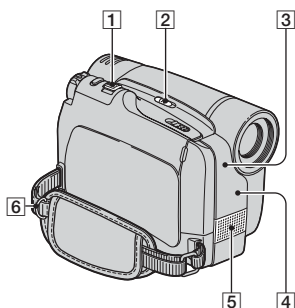

Wider range of view: (Wide angle)

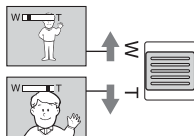

Close view: (Telephoto)

- You cannot change the zoom speed with the zoom buttons **12** on the LCD frame.
- The minimum possible distance between camcorder and subject while maintaining sharp focus is about 1 cm (about 13/32 in.) for wide angle and about 80 cm (about 2 5/8 feet) for telephoto.
- You can set [D ZOOM] (p. 45) if you want to zoom to a level greater than 20x.
- Be sure to keep your finger on the power zoom lever. If you move your finger off the power zoom lever, the operation sound of the power zoom lever may also be recorded.

To record in dark places (NightShot plus) **2**

Set the NIGHTSHOT PLUS switch **2** to ON. (☑ and ["NIGHTSHOT PLUS"] appear.)

- The NightShot plus function uses infrared light. Therefore, do not cover the infrared port **3** with your fingers or other objects. Remove the conversion lens (optional) if it is attached.
- Adjust the focus manually ([FOCUS], p. 38) when it is hard to focus automatically.
- Do not use these functions in bright places. This may cause a malfunction.

Recording

To use zoom **1 12**

Move the power zoom lever **1** slightly for a slower zoom. Move it further for a faster zoom.

To adjust the exposure for backlit subjects (BACK LIGHT) **7**

To adjust the exposure for backlit subjects, press BACK LIGHT **7** to display ☑. To cancel the back light function, press BACK LIGHT again.

To adjust the focus for an off center subject (SPOT FOCUS) **11**

See [SPOT FOCUS] on page 38.

To fix the exposure for the selected subject (Flexible spot meter) 11

See [SPOT METER] on page 38.

To record in mirror mode 13

Open the LCD panel 13 90 degrees to the camcorder (1), then rotate it 180 degrees to the lens side (2).

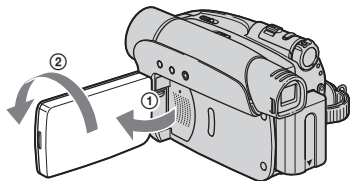

- A mirror-image of the subject appears on the LCD screen, but the picture will be normal when recorded.

To use a tripod 14

Attach the tripod (optional: the length of the screw must be less than 5.5 mm (7/32 in.)) to the tripod receptacle 14 using a tripod screw.

To use a Shoulder Belt 6

Attach the Shoulder Belt (optional) to its designated hook 6.

Playback

To play back the images with added special effects (Picture effect) 11

See [P EFFECT] on page 44.

Recording/playback

To check the remaining battery (Battery Info) 8

Set the POWER switch to OFF(CHG), then press DISP/BATT INFO 8. The battery information appears for about 7 seconds. You can view the battery information for up to 20 seconds by pressing DISP/BATT INFO again while the battery information is displayed.

Remaining battery (approx.)

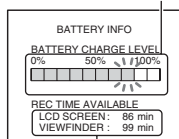

Recording capacity (approx.)

To turn off the operation confirmation beep (BEEP) 11

See [BEEP] on page 50.

To initialize the settings (RESET) 9

Press RESET 9 to initialize all the settings, including the setting of the date and time.

Other part names and functions

4 Remote sensor (DCR-HC24E/HC35E)
Point the Remote Commander (p. 30) towards the remote sensor to operate your camcorder.

5 Internal stereo microphone

10 Speaker
Playback sound comes out from the speaker.

- For how to adjust the volume, see page 23.

Indicators displayed during recording/playback

Recording

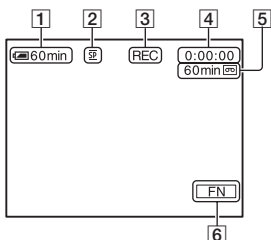

- 1 Remaining battery (approx.)
- 2 Recording mode (SP or LP) (48)
- 3 Recording status ([STBY] (standby) or [REC] (recording))
- 4 Recording: Tape counter (hour: minute: second)/Tape photo recording (22)
Playback: Tape counter (hour: minute: second)/Time code (hour: minute: second: frame)
- 5 Recording capacity of the tape (approx.) (49)
- 6 Function button (36)

Viewing

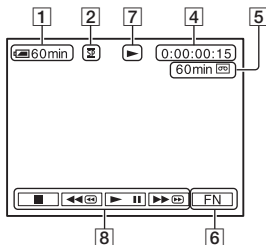

- 7 Tape transport indicator
- 8 Video operation buttons (23)

Data code during recording

The date/time during recording and the camera setting data will be recorded automatically. They do not appear on the screen during recording, but you can check them as [DATA CODE] during playback (p. 41).

() is a reference page.

The indicators during recording will not be recorded.

Indicators when you made changes

You can use [DISP GUIDE] (p. 16) to check the function of each indicator that appears on the LCD screen.

- Some of the indicators may not appear when you use [DISP GUIDE].

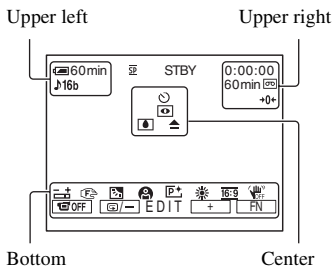

Upper left

Indicator	Meaning
16b	AUDIO MODE (48)

Upper right

Indicator	Meaning
DV IN	DV input (54)
+0+	Zero set memory (30)

Center

Indicator	Meaning
Clock	Self-timer recording (41)
Eye	NightShot plus (24)
Warning	Warning (80)

Bottom

Indicator	Meaning
Flexible spot meter	Flexible spot meter (38)/ Manual exposure (40)
Manual focus	Manual focus (38)
Backlight	Backlight (24)
PROGRAM AE	PROGRAM AE (44)
Picture effect	Picture effect (44)
White balance	White balance (40)
Wide select	Wide select (46)
SteadyShot off	SteadyShot off (46)
Panel off	Panel off (39)
EDITSEARCH	EDITSEARCH (46)

Searching for the starting point

Make sure that the CAMERA lamp lights up (p. 22).

Searching for the last scene of the most recent recording (END SEARCH)

[END SCH] (END SEARCH) will not work once you eject the cassette after you have recorded on the tape.

Touch **[FN]** → **[PAGE1]**, then touch **[END SCH]**.

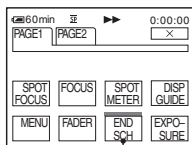

Touch here again to cancel the operation.

The last scene of the most recent recording is played back for about 5 seconds, and the camcorder enters the standby mode at the point where the last recording has finished.

- [END SCH] will not work correctly when there is a blank section between recorded sections on the tape.
- This operation is also available when the POWER switch is set to PLAY/EDIT.

Searching manually (EDIT SEARCH)

You can search for the start point to start the next recording while viewing the pictures on the screen. The sound is not played back during the search.

1 Touch **[FN]** → **[PAGE1]** → **[MENU]**.

2 Select **[CAMERA SET]** with **[↓]** / **[↑]**, then touch **[EXEC]**.

3 Select **[EDITSEARCH]** with **[↓]** / **[↑]**, then touch **[EXEC]**.

4 Select **[ON]** with **[↓]** / **[↑]**, then touch **[EXEC]** → **[×]**.

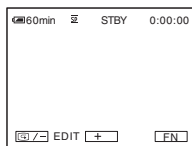

5 Touch and hold **[←]** (to go backward) / **[→]** (to go forward) and release it at the point where you want the recording to start.

Reviewing the most recently recorded scenes (Rec review)

You can view a few seconds of the scene recorded just before you stopped the tape.

1 Touch **[FN]** → **[PAGE1]** → **[MENU]**.

2 Select **[CAMERA SET]** with **[↓]** / **[↑]**, then touch **[EXEC]**.

3 Select **[EDITSEARCH]** with **[↓]** / **[↑]**, then touch **[EXEC]**.

4 Select **[ON]** with **[↓]** / **[↑]**, then touch **[EXEC]** → **[X]**.

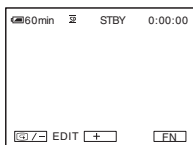

5 Touch **[G/-]**.

The last few seconds of the most recently recorded scene are played back. Then, your camcorder is set to the standby.

Remote Commander (DCR-HC24E/HC35E)

Remove the insulation sheet before using the Remote Commander.

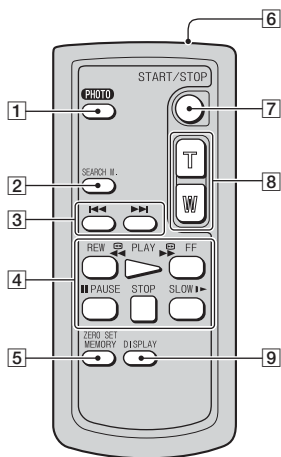
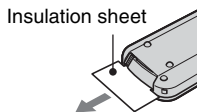

- 1** PHOTO* (p. 22)
The on-screen image when you press this button will be recorded as a still image.
- 2** SEARCH M.* (p. 31)
- 3** ◀▶▶*
- 4** Video control buttons (Rewind, Playback, Fast-forward, Pause, Stop, Slow) (p. 23)
- 5** ZERO SET MEMORY*
- 6** Transmitter
- 7** REC START/STOP (p. 20, 22)
- 8** Power zoom (p. 24)
- 9** DISPLAY (p. 16)
Press this button to hide the screen indicators.

* These buttons are not available during Easy Handycam operation.

- Aim the Remote Commander towards the remote sensor to operate your camcorder (p. 25).
- To change the battery, see page 89.

Searching quickly for a desired scene (Zero set memory)

1 During playback, press ZERO SET MEMORY **5** at a point you want to locate later on.

The tape counter is reset to "0:00:00" and +0+ appears on the screen.

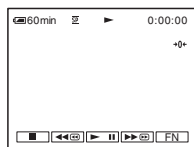

If the tape counter is not displayed, press DISPLAY **9**.

2 Press STOP **4** when you want to stop playback.

3 Press ◀◀REW **4**.

The tape stops automatically when the tape counter reaches "0:00:00."

4 Press PLAY **4**.

Playback starts from the point designated "0:00:00" on the tape counter.

To cancel the operation

Press ZERO SET MEMORY **5** again.

- There may be a discrepancy of several seconds between the time code and the tape counter.

- Zero set memory will not function correctly if there is a blank section between recorded sections on the tape.

Searching for a scene by date of recording (Date search)

You can locate the point where the recording date changes.

1 Slide the **POWER** switch repeatedly to turn on the **PLAY/EDIT** lamp.

2 Press **SEARCH M.** [2] to select **[DATE SEARCH]**.

3 Press **I◀◀(previous)/▶▶I(next)** [3] to select a recording date.

Each time you press **I◀◀** or **▶▶I**, your camcorder searches for the previous or next date from the current point on the tape.



To cancel the operation

Press **STOP** [4].

- The Date search will not function correctly when there is a blank section between recorded sections on the tape.

Searching for a still image (Photo search)

Your camcorder can search for the still image automatically, regardless of the recording date.

1 Slide the **POWER** switch repeatedly to turn on the **PLAY/EDIT** lamp.

2 Press **SEARCH M.** [2] to select **[PHOTO SEARCH]**.

3 Press **I◀◀(previous)/▶▶I(next)** [3] to select a photo.

Each time you press **I◀◀** or **▶▶I**, your camcorder searches for the still image before or after the current point on the tape.

To cancel the operation

Press **STOP** [4].

- The Photo search will not function correctly if there is a blank section between recorded sections on the tape.

Playing back still images in sequence (Photo scan)

You can locate still images one after another and display each image for 5 seconds automatically.

1 Slide the **POWER** switch repeatedly to turn on the **PLAY/EDIT** lamp.

Remote Commander (Continued)

2 Press SEARCH M. **[2]** to select [PHOTO SCAN].

3 Press **I◀◀(previous)/▶▶I(next)** **[3]**.

To cancel the operation

Press STOP **[4]**.

- The Photo scan will not function correctly if there is a blank section between recorded sections on the tape.

Playing the picture on a TV

You can connect your camcorder to the input jack of a TV or a VCR using the A/V connecting cable (1) or the A/V connecting cable with S VIDEO (2). Connect your camcorder to the wall socket using the supplied AC Adaptor for this operation (p. 9). Refer also to the instruction manuals supplied with the devices to be connected.

- For DCR-HC35E:

Do not insert/eject the cassette while your camcorder is on the Handycam Station. This may cause a malfunction.

DCR-HC23E/HC24E/HC26E:

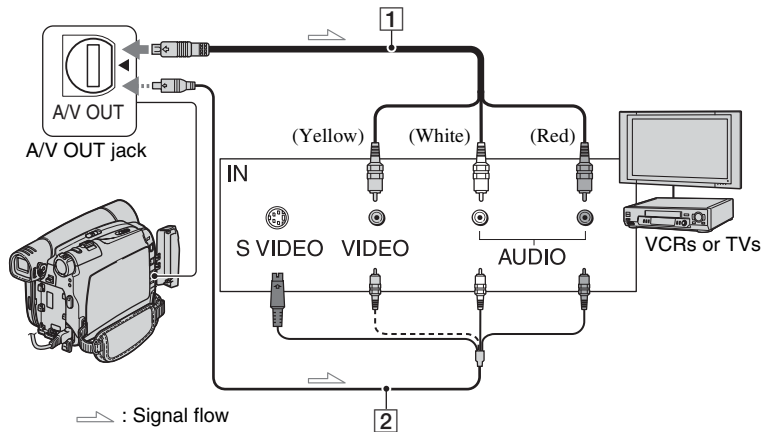

DCR-HC35E:

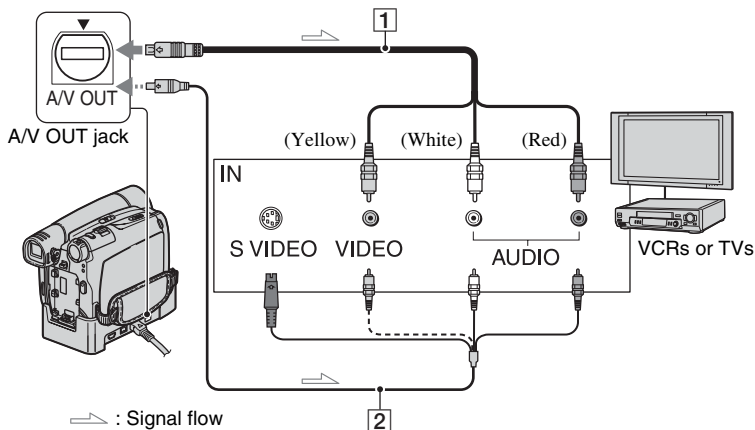

Playing the picture on a TV (Continued)

1 A/V connecting cable (supplied)

For DCR-HC35E:

The Handycam Station and your camcorder are both equipped with A/V OUT jacks (p. 57). Connect the A/V connecting cable either to the Handycam Station or to your camcorder, depending on your setup.

2 A/V connecting cable with S VIDEO (optional)

When connecting to another device via the S VIDEO jack, by using the A/V connecting cable with an S VIDEO cable, pictures can be reproduced more faithfully than with the supplied A/V cable connection.

Connect the white and red plugs (left/right audio) and S VIDEO plug (S VIDEO channel) of an A/V connecting cable. In this case, the yellow (standard video) plug connection is not necessary. S VIDEO connection only will not output audio.

- You can display the time code on the TV screen by setting [DISP OUT] to [V-OUT/LCD] (p. 50).
- For DCR-HC35E:
Do not connect A/V connecting cable to both the Handycam Station and your camcorder at the same time, as image disturbance may occur.

When connecting your camcorder to a TV through a VCR

Connect your camcorder to the LINE IN input on the VCR. Set the input selector on the VCR to LINE (VIDEO 1, VIDEO 2, etc.), if the VCR has an input selector.

When your TV is monaural (Only one audio input jack)

Connect the yellow plug of the A/V connecting cable to the video input jack and connect the white (left channel) or the red (right channel) plug to the audio input jack of your TV or VCR.

If your TV/VCR has a 21-pin adaptor (EUROCONNECTOR)

You need the 21-pin adaptor to connect your camcorder to a TV for viewing recorded images. This adaptor is designed for output use only. This output only adaptor is supplied with the DCR-HC35E model with the **CE** label on the bottom panel but not with DCR-HC23E/HC24E/HC26E models.

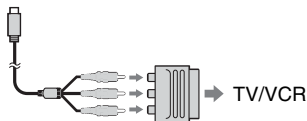

Using the menu items

Follow the instructions below to use each of the menu items listed after this page.

1 Slide the POWER switch in the direction of the arrow repeatedly to turn on the respective lamp.

CAMERA lamp: settings for recording on a tape

PLAY/EDIT lamp: settings for viewing/editing

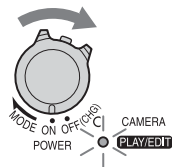

2 Touch the LCD screen to select the menu item.

Unavailable items will be grayed out.

■ To use the operation buttons on PAGE1/PAGE2/PAGE3 during normal operation

For details of the button items, see page 38.

- ① Touch .
- ② Touch the desired page.
- ③ Touch the desired button.
- ④ Select the desired setting, then touch → (Close).
 - With some settings, you do not have to touch .

■ To use menu items

For details of the items, see page 44.

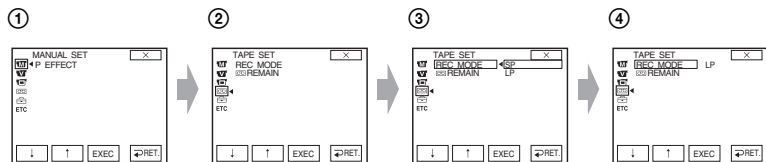

- ① Touch → [MENU] on [PAGE1].
The menu index screen appears.
- ② Select the desired menu.
Touch / to select the item, then touch [EXEC]. (The process in step ③ and ④ is the same as that in step ②.)
- ③ Select the desired item.
- ④ Customize the item.
After finishing the settings, touch (close) to hide the menu screen.
Each touch of [] takes you to the previous screen.

■ To use menu items during Easy Handycam operation

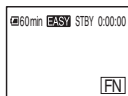

- ① Touch .
 - ② Select the desired menu.
Touch [MENU] then select the desired menu.
 - ③ Change your item setting.
After finishing the settings, touch (close) to hide the menu screen.
Each touch of [] takes you to the previous screen.
 - Cancel Easy Handycam operation to use menu items normally.
-

Operation button items

Available operation buttons vary depending on the position of the lamp and the display (PAGE).

The default settings are marked with ►.

The indicators in parentheses appear when the items are selected.

The available functions during Easy Handycam operation are marked with*.

See page 36 for details on selecting button items.

When the CAMERA lamp lights up

[PAGE1]

SPOT FOCUS

You can select and adjust the focal point to aim it at a subject not located in the center of the screen.

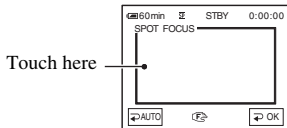

Touch the point where you want to focus on in the frame.

☞ appears.

To adjust the focus automatically, touch [☞ AUTO] or set [FOCUS] to [☞ AUTO].

- If you set [SPOT FOCUS], [FOCUS] is automatically set to [MANUAL].
- The setting returns to [☞ AUTO] when you turn the power off for more than 12 hours.

FOCUS

You can adjust the focus manually. You can select this function also when you want to focus on a certain subject intentionally.



- ① Touch [MANUAL].

☞ appears.

- ② Touch [☞] (focusing on close subjects)/ [☞] (focusing on distant subjects) to sharpen the focus. ☞ appears when the focus cannot be adjusted any closer, and ▲ appears when the focus cannot be adjusted farther away.

To adjust the focus automatically, touch [☞ AUTO] in step ①.

- It is easier to focus on the subject by moving the power zoom lever towards T (telephoto) to adjust the focus, then towards W (wide angle) to adjust the zoom for recording. When you want to record a subject at close range, move the power zoom lever to W (wide angle), then adjust the focus.
- The minimum possible distance between camcorder and subject while maintaining sharp focus is about 1 cm (about 13/32 in.) for wide angle and about 80 cm (about 2 5/8 feet) for telephoto.
- The setting returns to [☞ AUTO] when you turn the power off for more than 12 hours.

SPOT METER (Flexible spot meter)

You can adjust and fix the exposure to the subject, so that it is recorded in suitable brightness even when there is strong contrast between the subject and the background, such as subjects in the spotlight on stage.

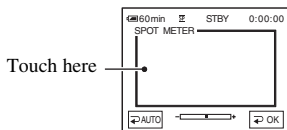

Touch the point where you want to fix and adjust the exposure on the screen.

☞ appears.

To return the setting to automatic exposure, touch [↔ AUTO] or set [EXPOSURE] to [↔ AUTO].

- If you set [SPOT METER], [EXPOSURE] is automatically set to [MANUAL].
- The setting returns to [↔ AUTO] when you turn the power off for more than 12 hours.

DISP GUIDE (Display Guide)*

See page 16.

MENU*

See page 43.

FADER

You can add the following effects to currently recording pictures.

- ① Select the desired effect in standby mode (to fade in) or recording mode (to fade out), then touch [↔ OK] → [×].
- ② Press REC START/STOP.

The fader indicator stops flashing and disappears when the fade is complete.

To cancel [FADER] before starting the operation, touch [↔ OFF] in step ①.

- If you press REC START/STOP once, the setting is canceled.



WHITE



BLACK



MOSC. FADER



MONOTONE

When fading in, the picture gradually changes from black and white to color. When fading out, it gradually changes from color to black and white.

Using the viewfinder

You can adjust [EXPOSURE] and [FADER] while using the viewfinder by having the LCD panel rotated 180 degrees and closed with the screen facing out.

- 1 Make sure that the CAMERA lamp lights up.
- 2 Close the LCD panel with the screen facing out.
[OFF] appears.
- 3 Touch [OFF].
- 4 Touch [OK].
The LCD screen is turned off.
- 5 Touch the LCD screen while checking the display in the viewfinder.
[EXPOSURE], etc. are displayed.
- 6 Touch the button you want to set.
[EXPOSURE]: Adjust with [−]/[+], and touch [↔ OK].
[FADER]: Touch it repeatedly to select a desired effect.
[ON]: The LCD screen lights up.

To hide the buttons, touch [↔ OK].

END SCH (END SEARCH)

See page 28.

EXPOSURE

You can fix the brightness of a picture manually. When recording indoors on a clear day, for instance, you can avoid backlight shadows on people next to the window by fixing the exposure to that of the wall side of the room.

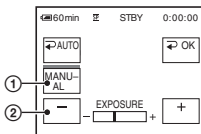

① Touch [MANUAL].

← → appears.

② Adjust the exposure by touching / .

To return the setting to automatic exposure, touch [AUTO].

- You can adjust [EXPOSURE] and [FADER] while using the viewfinder by having the LCD panel rotated 180 degrees and closed with the screen facing out (p. 39).
- The setting returns to [AUTO] when you turn the power off for more than 12 hours.

[PAGE2]

WHT BAL (White balance)

You can adjust the color balance to the brightness of the recording environment.

▶ AUTO

The white balance is adjusted automatically.

OUTDOOR (☀)

The white balance is adjusted to be appropriate for the following recording conditions:

- Outdoors
- Night views, neon signs and fireworks
- Sunrise or sunset
- Under daylight fluorescent lamps

INDOOR (☾)

The white balance is adjusted to be appropriate for the following recording conditions:

- Indoors
- At party scenes or studios where the lighting conditions change quickly
- Under video lamps in a studio, or under sodium lamps or incandescent-like color lamps

ONE PUSH (📷)

The white balance will be adjusted according to the ambient light.

① Touch [ONE PUSH].

② Frame a white object such as a piece of paper, to fill the screen under the same lighting conditions as you will shoot the subject.

③ Touch .

- flashes quickly. When the white balance has been adjusted and stored in the memory, the indicator stops flashing.
- Do not shake your camcorder while is flashing quickly.
- flashes slowly if white balance could not be set.
- If keeps flashing even after you have touched [OK], set [WHT BAL] to [AUTO].

- If you have changed the battery pack while [AUTO] is selected, taken your camcorder outdoors or brought it indoors after outside use while using fixed exposure, select [AUTO] and aim your camcorder at a nearby white object for about 10 seconds for better color balance adjustment.
- Redo the [ONE PUSH] procedure if you change the [PROGRAM AE] settings, or bring your camcorder outdoors from inside the house, or vice versa.
- Set [WHT BAL] to [AUTO] or [ONE PUSH] under white or cool white fluorescent lamps.
- The setting returns to [AUTO] when you turn the power off for more than 12 hours.

SELF TIMER

The self-timer starts recording after about 10 seconds.

- ① Touch **[FN]** → [PAGE2] → [SELF TIMER].
☺ appears.
- ② Touch **[X]**.
- ③ Press REC START/STOP to record movies, or PHOTO to record still images.

To cancel the count down during recording movies, press REC START/STOP.

To cancel [SELF TIMER], redo step ①.

- For DCR-HC24E/HC35E:
You can also set the self-timer with the REC START/STOP button or PHOTO button of the Remote Commander (p. 30).

LCD BRT (LCD bright)

You can adjust the brightness of the LCD screen. The recorded picture will not be affected by this operation.

Adjust the brightness with **[−]**/**[+]**.

When the PLAY/EDIT lamp lights up

You can use the video operation buttons (**[■]**/**[◀▶]**/**[▶▶]**) on every PAGE.

[PAGE1]

MENU*

See page 43.

VOL* (Volume)

See page 23.

END SCH (END SEARCH)

See page 28.

DISP GUIDE (Display Guide)*

See page 16.

[PAGE2]

DATA CODE*

During playback, displays information (data code) recorded automatically at the time of recording.

▶ OFF

Data code is not displayed.

DATE/TIME

Displays the date and time.

CAM DATA (below)

Displays camera setting data.

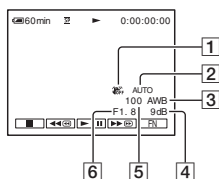

- 1 SteadyShot off
- 2 Exposure
- 3 White balance
- 4 Gain
- 5 Shutter speed
- 6 Aperture value

- In the [DATE/TIME] data display, the date and time are displayed in the same area. If you record a picture without setting the clock, [---:---:---] and [---:---:---] will appear.
- During Easy Handycam operation, you can set [DATE/TIME] only.

LCD BRT (LCD bright)

You can adjust the brightness of the LCD screen. The recorded picture will not be affected by this operation.

Adjust the brightness with **[−]**/**[+]**.

Operation button items (Continued)

BURN DVD

When your camcorder is connected to a Sony VAIO series personal computer, you can easily burn the picture recorded on the tape on a DVD (Direct Access to "Click to DVD") (p. 65).

BURN VCD









When your camcorder is connected to a personal computer, you can easily burn the picture recorded on the tape on a CD-R (Direct Access to Video CD Burn). See "First Step Guide" in the supplied CD-ROM for details (p. 64).

[PAGE3]

V SPD PLAY (Various speed playback)

You can play back in various modes while viewing movies.

- ① Touch the following buttons during playback.

To	Touch
change the playback direction*	 (frame)
play back slowly**	 SLOW] To reverse direction:  (frame) →  SLOW]
play back 2 times faster (double speed)	 ×2 (double speed) To reverse direction:  (frame) →  ×2 (double speed)
play back frame by frame	 (frame) during playback pause. To reverse direction:  (frame) during frame playback.

* Horizontal lines may appear at the top, bottom, or in the center of the screen. This is not a malfunction.

**Pictures output from the  DV Interface (i.LINK) cannot be played back smoothly in slow mode.

- ② Touch  RET.] → .

To return to the normal playback mode, touch  (Play/Pause) twice (once from frame playback).

- You will not hear the recorded sound. You may see mosaic-like images of the previously played picture.

A DUB CTRL (Audio dubbing)

See page 56.

REC CTRL (Recording control) (DCR-HC26E/HC35E)

See page 54.

Menu items

- Available menu items (●) vary depending on which lamp is lit.
- During Easy Handycam operation, the following settings are automatically applied (p. 20).

	CAMERA	PLAY/EDIT	Easy Handycam
TM MANUAL SET menu (p. 44)			
PROGRAM AE	●	–	AUTO
P EFFECT	●	●	OFF
AUTO SHTR	●	–	ON
C CAMERA SET menu (p. 45)			
D ZOOM	●	–	OFF
WIDE SEL	●	–	4:3
STEADYSHOT	●	–	ON
EDITSEARCH	●	–	OFF
N.S.LIGHT	●	–	ON
P PLAYER SET (DCR-HC23E/HC24E)/			
V VCR SET (DCR-HC26E/HC35E) menu (p. 47)			
HiFi SOUND	–	●	STEREO
AUDIO MIX	–	●	–
L LCD/VF SET menu (p. 47)			
LCD B.L.	●	●	BRT NORMAL
LCD COLOR	●	●	–
VF B.L.	●	●	BRT NORMAL
WIDE DISP	●	●	–
OO TAPE SET menu (p. 48)			
REC MODE (DCR-HC23E/HC24E)	●	–	SP
REC MODE (DCR-HC26E/HC35E)	●	●	SP
AUDIO MODE	●	–	12BIT
OO REMAIN	●	●	AUTO
IB SETUP MENU menu (p. 49)			
CLOCK SET	●	●	●
USB STREAM	●	●	OFF
A LANGUAGE	●	●	●
DEMO MODE	●	–	ON
ETC OTHERS menu (p. 50)			
WORLD TIME	●	●	–*
BEEP	●	●	●
A.SHUT OFF	●	●	5min
COMMANDER (DCR-HC24E/HC35E)	●	●	ON
DISP OUT	●	●	LCD

* The value set before Easy Handycam operation will be retained during Easy Handycam operation.

MANUAL SET menu

– PROGRAM AE/P EFFECT, etc.

The default settings are marked with ►. The indicators in parentheses appear when the items are selected.

See page 36 for details on selecting menu items.

PROGRAM AE

You can record pictures effectively in various situations with the PROGRAM AE function.

► AUTO

Select to automatically record pictures effectively without the [PROGRAM AE] function.

SPOTLIGHT* (☺)

Select to prevent people's faces from appearing excessively white when subjects are lit by strong light.



PORTRAIT (Soft portrait) (👤)

Select to bring out the subject such as people or flowers while creating a soft background.



SPORTS* (Sports lesson) (⚽)

Select to minimize shake when shooting fast moving subjects.



BEACH&SKI* (🏖️)

Select to prevent people's faces from appearing dark in strong light or reflected light, such as at a beach in midsummer or on a ski slope.



SUNSETMOON** (🌅)

Select to maintain the atmosphere of situations such as sunsets, general night views or fireworks.



LANDSCAPE** (🏞️)

Select to shoot distant subjects clearly. This setting also prevents your camcorder from focusing on glass or metal mesh in windows that comes in between the camcorder and the subject.



- Items with one asterisk (*) can be adjusted to focus on subjects only a short distance away. Items with two asterisks (**) can be adjusted to focus on subjects farther away.
- The setting returns to [AUTO] when you turn the power off for more than 12 hours.

P EFFECT (Picture effect)

You can add special effects to a picture during recording or playback.  appears.

► OFF

Does not use [P EFFECT] setting.

NEG.ART

The color and brightness are reversed.



CAMERA SET menu

– D ZOOM/WIDE SEL/STEADYSHOT, etc.

SEPIA

Pictures appear in sepia.

B&W

Pictures appear in black and white.

SOLARIZE

Pictures appear as an illustration with strong contrast.



PASTEL*

Pictures appear as a pale pastel drawing.



MOSAIC*

Pictures appear mosaic-patterned.



* Not available during playback.

- You can record pictures edited with special effects on another VCR/DVD device, etc. (p. 51).
- You cannot output playback pictures edited with picture effects via the DV Interface (i.LINK).
- For DCR-HC26E/HC35E:
You cannot add effects to externally input pictures.

AUTO SHTR (Auto shutter)

Automatically activates the electronic shutter to adjust the shutter speed when recording in bright conditions if you set it to [ON] (the default setting).

The default settings are marked with ►. The indicators in parentheses appear when the items are selected.

See page 36 for details on selecting menu items.

D ZOOM (Digital zoom)

You can select the maximum zoom level in case you want to zoom to a level greater than 20 × (the default setting) while recording on a tape. Note that the image quality decreases when you are using the digital zoom.

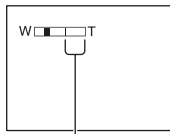

The right side of the bar shows the digital zooming factor. The zooming zone appears when you select the zooming level.

► OFF

Up to 20 × zoom is performed optically.

40 ×

Up to 20 × zoom is performed optically, and after that, up to 40 × zoom is performed digitally.

640 × (DCR-HC23E)

Up to 20 × zoom is performed optically, and after that, up to 640 × zoom is performed digitally.

800 × (DCR-HC24E/HC26E/HC35E)

Up to 20 × zoom is performed optically, and after that, up to 800 × zoom is performed digitally.

WIDE SEL (Wide select)

You can record a picture in a ratio suitable for the screen on which it will be displayed. Refer also to the operating instructions supplied with your TV for details.

▶ 4:3

Standard setting (to record pictures to be played back on a 4:3 TV).

16:9 WIDE ()

Records pictures to be played back on a 16:9 wide TV in full screen mode.

When viewed on the LCD screen/viewfinder with [16:9 WIDE] selected.

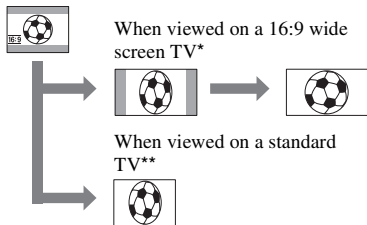

* Picture appears in full screen mode when the wide-screen TV switches to full mode.

** Played in 4:3 mode. When you play a picture in the wide mode, it appears as you have seen on the LCD screen or in the viewfinder.

STEADYSHOT



You can compensate for camera shake (the default setting is [ON]). Set [STEADYSHOT] to [OFF] () when using a tripod (optional) or the conversion lens (optional), then the image becomes natural.

EDITSEARCH

▶ OFF

Does not display  or  on the LCD screen.

ON

Displays  and  on the LCD screen, and enables the EDIT SEARCH function and Rec review (p. 28).

N.S.LIGHT (NightShot Light)

When using the NightShot plus (p. 24) function to record, you can record clearer pictures by setting [N.S.LIGHT], which emits infrared light (invisible), to [ON] (the default setting).

- Do not cover the infrared port with your fingers or other objects (p. 24).
- Remove the conversion lens (optional) if it is attached.
- The maximum shooting distance using [N.S.LIGHT] is about 3 m (10 feet). If you record subjects in dark places, such as night scenes or in moonlight, set [N.S.LIGHT] to [OFF]. You can make the image color deeper this way.

PLAYER SET/ **VCR SET menu**

– HiFi SOUND/AUDIO MIX

The **PLAYER SET** menu is for the DCR-HC23E/HC24E, and the **VCR SET** menu is for the DCR-HC26E/HC35E.

The default settings are marked with ►. The indicators in parentheses appear when the items are selected.

See page 36 for details on selecting menu items.

HiFi SOUND

You can select whether to play back audio recorded using other devices with dual sound or stereo sound.

► STEREO

Plays back with main and sub sound (or stereo sound).

1

Plays back with main sound (or the left channel sound).

2

Plays back with sub sound (or the right channel sound).

- You can play back, but cannot record a dual sound track cassette on your camcorder.
- The setting returns to [STEREO] when you turn the power off for more than 12 hours.

AUDIO MIX

See page 56.

LCD/VF SET menu

– LCD B.L./LCD COLOR/VF B.L., etc

The default settings are marked with ►. The indicators in parentheses appear when the items are selected.

See page 36 for details on selecting menu items.

LCD B.L. (LCD back light)

You can adjust the brightness of the LCD screen's backlight. The recorded picture will not be affected by this operation.

► BRT NORMAL



Standard brightness.

BRIGHT

Brightens the LCD screen.

- When you connect your camcorder to outside power sources, [BRIGHT] is automatically selected for the setting.
- When you select [BRIGHT], battery life is slightly reduced during recording.

LCD COLOR

You can adjust the color on the LCD screen with  / . The recorded picture will not be affected by this operation.

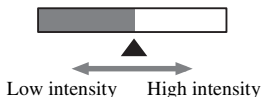

VF B.L. (Viewfinder back light)

You can adjust the brightness of the viewfinder. The recorded picture will not be affected by this operation.

► BRT NORMAL

Standard brightness.

BRIGHT

Brightens the viewfinder screen.

- When you connect your camcorder to outside power sources, [BRIGHT] is automatically selected for the setting.

- When you select [BRIGHT], battery life is slightly reduced during recording.

WIDE DISP (Wide display)

You can select how a 16:9 aspect ratio picture appears in the viewfinder and the LCD screen by setting [WIDE SEL] to [16:9 WIDE]. The recorded picture will not be affected by this operation.

▶ LETTER BOX

Normal setting (standard type of display)

SQUEEZE

Expands the picture vertically if black bands at the top and bottom in 16:9 aspect ratio are undesirable.

– REC MODE/AUDIO MODE/REMAIN

The default settings are marked with ▶. The indicators in parentheses appear when the items are selected.

See page 36 for details on selecting menu items.

REC MODE (Recording mode)

▶ SP (SP)

Records in the SP (Standard Play) mode on a cassette.

LP (LP)

Increases the recording time to 1.5 times the SP mode (Long Play).

- You can record about 510 still images in the SP mode and about 765 still images in the LP mode on a 60 minutes tape.
- If you record in the LP mode, a mosaic-like noise may appear or sound may be interrupted when you play back the tape on other camcorders or VCRs.
- When you mix recordings in the SP mode and in the LP mode on one tape, the playback picture may be distorted or the time code may not be written properly between the scenes.

AUDIO MODE

▶ 12BIT

Records in the 12-bit mode (2 stereo sounds).

16BIT (16b)

Records in the 16-bit mode (1 stereo sound with high quality).



SETUP MENU

menu

– CLOCK SET/USB STREAM/LANGUAGE, etc.

The default settings are marked with ►. The indicators in parentheses appear when the items are selected.

See page 36 for details on selecting menu items.

REMAIN

► AUTO

Displays the remaining tape indicator for about 8 seconds in situations such as those described below.

- When you set the POWER switch to PLAY/EDIT or CAMERA with a cassette inserted.
- When you touch (Play/Pause).

ON

Always displays the remaining tape indicator.

CLOCK SET

See page 18.

USB STREAM

You can view the pictures displayed on the screen of your camcorder on your computer (USB Streaming) via the USB cable. See “First Step Guide” in the supplied CD-ROM for details (p. 64).

LANGUAGE

You can select the language to be used on the LCD screen.

- Your camcorder offers [ENG[SIMP]] (simplified English) for when you cannot find your native tongue among the options.

DEMO MODE

The default setting is [ON], allowing you to view the demonstration in about 10 minutes, after you have removed a cassette from your camcorder, and slide the POWER switch repeatedly to turn on the CAMERA lamp.

- The demonstration will be suspended in situations such as those described below.
 - When you touch the screen during the demonstration. (The demonstration starts again after about 10 minutes.)
 - When a cassette is inserted.
 - When the POWER switch is set to other than CAMERA.



ETC OTHERS menu

– WORLD TIME/BEEP, etc.

The default settings are marked with ►.
The indicators in parentheses appear when the items are selected.

See page 36 for details on selecting menu items.

WORLD TIME

When using your camcorder abroad, you can set the time difference by touching  / , the clock will be adjusted in accordance with the time difference.

If you set the time difference to 0, the clock returns to the originally set time.

BEEP

► ON

A melody sounds when you start/stop recording, or operate the touch panel.

OFF

Cancels the melody.

A.SHUT OFF (Auto shut off)

► 5min

The camcorder is automatically turned off when you do not operate your camcorder for more than approximately 5 minutes.

NEVER

The camcorder is not automatically turned off.

- When you connect your camcorder to a wall socket, [A.SHUT OFF] is automatically set to [NEVER].

COMMANDER (DCR-HC24E/HC35E)

The default setting is [ON], allowing you to use the Remote Commander (p. 30).

- Set to [OFF] to prevent your camcorder from responding to a command sent by another VCR remote control unit.

DISP OUT (Display output)

► LCD

Shows displays such as the time code on the LCD screen and in the viewfinder.

V-OUT/LCD

Shows displays such as the time code on the TV screen, LCD screen, and in the viewfinder.

Dubbing to VCR/DVD device, etc.

You can copy the picture played back on your camcorder to other recording devices (VCR/ DVD device, etc.).

You can connect your camcorder to a VCR/DVD device, etc., using the A/V connecting cable (1), the A/V connecting cable with S VIDEO (2), or the i.LINK cable (3).

Connect your camcorder to the wall socket using the supplied AC Adaptor for this operation (p. 9). Refer also to the instruction manuals supplied with the devices to be connected.

- For DCR-HC35E:

Do not insert/eject the cassette while your camcorder is on the Handycam Station. This may cause a malfunction.

DCR-HC23E/HC24E/HC26E:

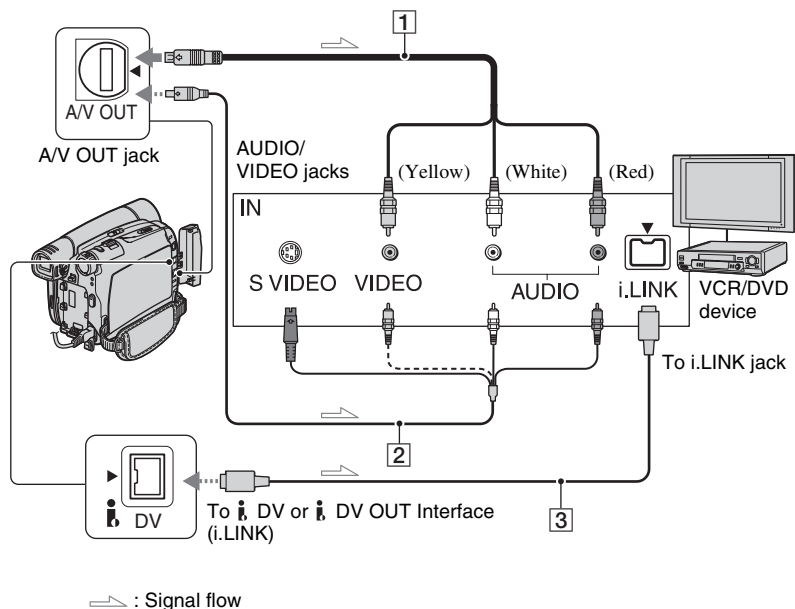

DCR-HC35E:

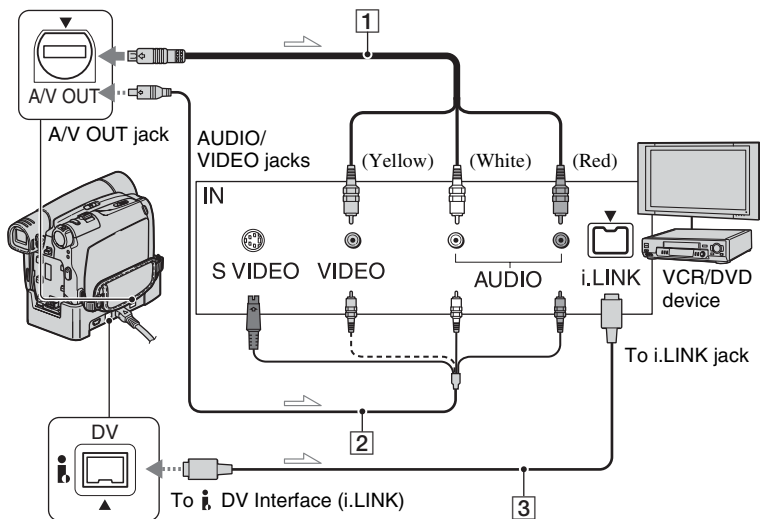

➡ : Signal flow

1 A/V connecting cable (supplied)

For DCR-HC35E:

The Handycam Station and your camcorder are both equipped with A/V OUT jacks (p. 57). Connect the A/V connecting cable either to the Handycam Station or to your camcorder, depending on your setup.

2 A/V connecting cable with S VIDEO (optional)

When connecting to another device via the S VIDEO jack, by using the A/V connecting cable with an S VIDEO cable, pictures can be reproduced more faithfully than with the supplied A/V cable connection. Connect the white and red plugs (left/right audio) and S VIDEO plug (S VIDEO channel) of an A/V connecting cable. In this case, the yellow (standard video) plug connection is not necessary. S VIDEO connection only will not output audio.

3 i.LINK cable (optional)

Use an i.LINK cable to connect your camcorder to another device equipped with an i.LINK jack. The video and audio signals are transmitted digitally, producing high quality pictures and sound. Note that you cannot output picture and sound separately.

- When you are connecting your camcorder to a monaural device, connect the yellow plug of the A/V connecting cable to the video jack, and the red (right channel) or the white (left channel) plug to the audio jack on the VCR/TV.
- When you connect a device via an A/V connecting cable, set [DISP OUT] to [LCD] (the default setting) (p. 50).

1 Prepare your camcorder for playback.

Insert the recorded cassette.

Slide the POWER switch repeatedly to turn on the PLAY/EDIT lamp.

2 Prepare your VCR/DVD device for recording.

When dubbing to the VCR, insert a cassette for recording.

When dubbing to the DVD recorder, insert a DVD for recording.

If your recording device has an input selector, set it to the appropriate input (such as video input1, video input2).

3 Connect your VCR/DVD device to your camcorder as a recording device.

Connect your camcorder to the input jacks of a VCR or a DVD device.

4 Start playback on the camcorder, and recording on the VCR/DVD device.

Refer to the operating instructions supplied with your recording device for details.

5 When dubbing is complete, stop your camcorder and the VCR/DVD device.

-
- To record the date/time and camera settings data when connected by the A/V connecting cable, display them on the screen (p. 41, 50).

- The following cannot be output via the  DV Interface (i.LINK):
 - Indicators
 - Pictures edited using [P EFFECT] (p. 44)
- When connected using an i.LINK cable, the recorded picture becomes rough when a picture is paused on your camcorder while recording to a VCR.
- When connected using an i.LINK cable, data code (date/time/camera settings data) may not be displayed or recorded depending on the device or application.

Recording pictures from a TV or VCR/DVD device, etc. (DCR-HC26E/HC35E)

You can record pictures or TV programs from a TV or VCR/DVD device, etc., on a tape. Be sure to insert a cassette for recording in your camcorder beforehand.

You can connect your camcorder to a TV, VCR/DVD or an i.LINK-compatible device using the i.LINK cable.

Connect your camcorder to the wall socket using the supplied AC Adaptor for this operation (p. 9). Refer also to the instruction manuals supplied with the devices to be connected.

- You cannot record pictures on your camcorder from a TV or VCR/DVD device that does not have an i.LINK jack.
- You cannot input picture and sound separately.
- Your camcorder can only record from a PAL source. For example, French system video/broadcasts (SECAM) will not be recorded correctly. See page 83 for details on TV color systems.
- For DCR-HC35E:
Do not insert/eject the cassette while your camcorder is on the Handycam Station. This may cause a malfunction.

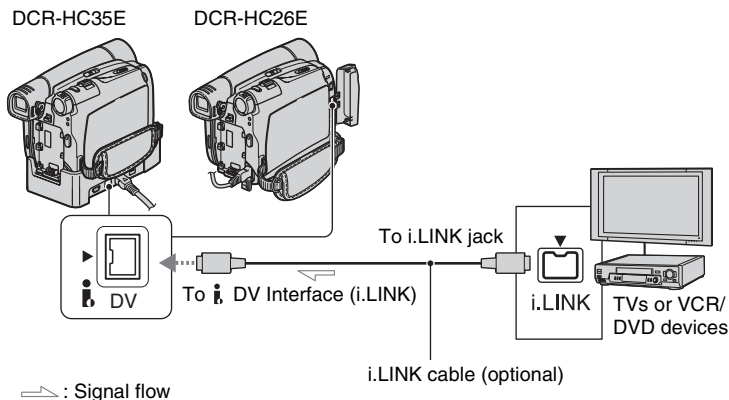

1 Connect your TV or VCR/DVD device to your camcorder with an i.LINK cable.

- The DV_{IN} indicator appears when you connect your camcorder and other devices via an i.LINK cable. (This indicator may also appear on the connected device.)

2 If you are recording from a VCR/DVD device, insert a cassette or a DVD.

3 Slide the POWER switch repeatedly to turn on the PLAY/EDIT lamp.

4 Set your camcorder to recording pause mode.

Touch **FN** → [PAGE3] → [REC CTRL] → [REC PAUSE].

5 When recording pictures from a VCR/DVD device:

Start playing the cassette or the disc on the VCR/DVD device.

When recording pictures from a TV:

Select a TV program.

The picture played on the connected device appears on the LCD screen of your camcorder.

6 Touch [REC START] at the point you want to start recording.

7 Stop recording.

Touch  (Stop) or [REC PAUSE].

8 Touch [RET.] → .

Dubbing sound to a recorded tape

You can add sound to a tape already recorded in the 12-bit mode (p. 48) without erasing the original sound.

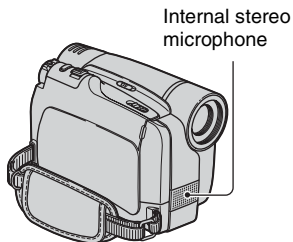

You can record audio by using the internal stereo microphone.

- You cannot record additional audio:
 - When the tape has been recorded in the 16-bit mode (p. 48).
 - When the tape has been recorded in the LP mode.
 - When your camcorder is connected via an i.LINK cable.
 - When the tape has been recorded in 4CH MIC mode.
 - On blank sections of the tape.
 - When the tape has been recorded in a TV color system other than that of your camcorder (p. 83).
 - When the write-protect tab of the cassette is set to SAVE (p. 83).
 - On sections recorded in HDV format.
- When you add sound, the picture will not be output from the A/V OUT jack. Check the picture on the LCD screen or the viewfinder.
- For DCR-HC35E:
 - Do not insert/eject the cassette while your camcorder is on the Handycam Station. This may cause a malfunction.

Dubbing sound to a recorded tape (Continued)

Recording sound

Insert a recorded cassette into your camcorder beforehand.

1 Slide the **POWER** switch repeatedly to turn on the **PLAY/EDIT** lamp.

2 Touch **[▶||]** (**Play/Pause**) to play back the tape, then touch it again at the point where you want to start recording the sound.

3 Touch **[FN]** → **[PAGE3]** → **[A DUB CTRL]** → **[AUDIO DUB]**.

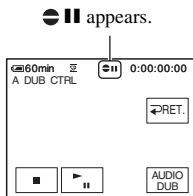

4 Touch **[▶||]** (**Play**) and start playing back the audio you want to record at the same time.

⊕ appears while recording the new sound in stereo 2 (ST2) during the playback of the tape.

5 Touch **[■]** (**Stop**) when you want to stop recording.

To dub on other scenes, repeat step 2 to select scenes, then touch **[AUDIO DUB]**.

6 Touch **[↶ RET.]** → **[X]**.

- You can only record additional audio over a tape recorded on your camcorder. The sound may deteriorate when you dub audio on a tape recorded on other camcorders (including other camcorders (DCR-HC23E/HC24E/HC26E/HC35E)).
- For DCR-HC24E/HC35E:
To set the end point for audio dubbing, beforehand, press **ZERO SET MEMORY** on the Remote Commander at the scene at which you want to stop audio dubbing during playback. After step 2 to 4, the recording stops automatically at the selected scene.

To check the recorded sound

- ① Play back the tape on which you have recorded audio (p. 23).
- ② Touch **[FN]** → **[PAGE1]** → **[MENU]**.
- ③ Select **[P]** (**PLAYER SET**) for the DCR-HC23E/HC24E, or **[V]** (**VCR SET**) for the DCR-HC26E/HC35E, then touch **[↓]** / **[↑]** to select **[AUDIO MIX]**, then touch **[EXEC]**.

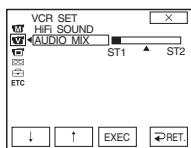

- ④ Touch **[↓]** / **[↑]** to adjust the balance of the original sound (ST1) and the new sound (ST2), then touch **[EXEC]**.
- The original sound (ST1) is output at the default setting.
 - Audio balance adjustment returns to the default setting after 12 hours of turning the power off.

Jacks to connect external devices

Camcorder

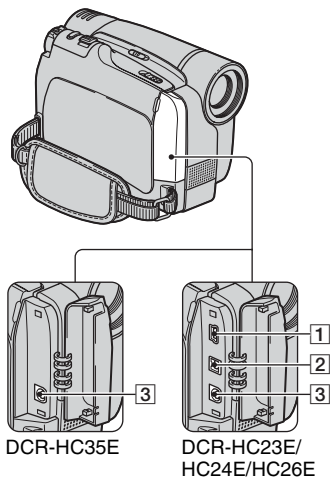

- 1 USB (USB) jack (p. 58)
- 2 For DCR-HC23E/HC24E:
DV OUT Interface (i.LINK) (p. 51, 65)
For DCR-HC26E/HC35E:
DV Interface (i.LINK) (p. 51, 54, 65)
- 3 A/V (audio/video) OUT jack (p. 33, 51)
 - For DCR-HC35E:
The Handycam Station and your camcorder are both equipped with A/V OUT jacks.
- 4 DC IN jack (p. 9)
- 5 For DCR-HC35E:
Interface connector

Bottom

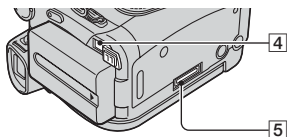

1 - 4 ...Open the jack cover.

Handycam Station (DCR-HC35E)

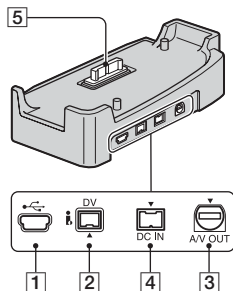

Before referring to the “First Step Guide” on your computer

When you install the Picture Package software on a Windows computer from the supplied CD-ROM, you can enjoy the following operations by connecting your camcorder to your computer.

- Software and features available for Macintosh computers differ from those available for Windows computers. For details, refer to chapter 6 of “First Step Guide” on the supplied CD-ROM. For “First Step Guide,” see page 60.
- There are 2 ways to connect your camcorder to a computer.
 - USB cable
This method is good for copying video and sound recorded on a tape to the computer. A USB cable is not supplied with the DCR-HC23E/HC26E models. If necessary, buy a USB 2.0 cable (Type A to Type B-mini). A Sony product is recommended.
 - i.LINK cable
This method is good for copying video and sound recorded on a tape. Image data is transferred in more clarity than with a USB cable.

For details on connection, see “First Step Guide.”

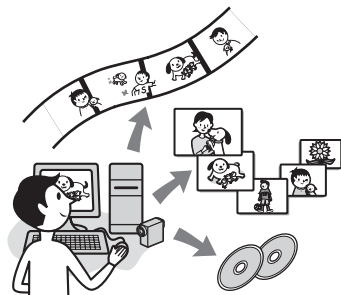

Viewing video and pictures on PC

You can view the video and still images copied from your camcorder by selecting from thumbnails. Video and still images are saved in folders by date.

Music Video/Slideshow Producer

You can select your favorite video and still images from video and still images saved on your computer and easily create an original short video or original slide show with added music and visual styles.

Automatic Music Video Producer

You can easily create an original short video with added music and visual styles using video recorded on a tape.

Copying tape to Video CD

You can import the entire contents of a tape to create a video CD.

Save the images on CD-R

You can save video and still images copied onto a computer to a CD-R.

Burning Video CD

You can compose a video CD with a menu of videos and slide shows. ImageMixer VCD2 is compatible with high resolution still images.

USB Streaming Tool

You can view live or recorded images from your camcorder on a computer.

Video Capturing Tool

You can import the entire contents of a tape to a computer.

- The CD-ROM (supplied) includes the following software:
 - USB Driver
 - Picture Package Ver.1.5.1
 - ImageMixer VCD2
 - “First Step Guide”

About “First Step Guide”

“First Step Guide” is an instruction manual you can refer to on your computer. This “First Step Guide” describes basic operations, from initial hookup of your camcorder and computer and making settings, to general operation the first time you use the software stored on the CD-ROM (supplied). Install the CD-ROM, read “Installing the software and “First Step Guide” on a computer” (p. 60), start the “First Step Guide,” then follow the instructions.

About the help function of the software

The Help guide explains all software application functions. Refer to the Help guide for further detailed operations after reading the “First Step Guide” thoroughly. To display the Help guide, click the [?] mark on the screen.

System requirements

■ For Windows users

When using Picture Package

OS: Microsoft Windows 2000

Professional, Windows Millennium Edition, Windows XP Home Edition or Windows XP Professional Standard installation is required.

Operation is not assured if the above OS has been upgraded.

CPU: Intel Pentium III 500 MHz or faster (800 MHz or faster recommended) (For using ImageMixer VCD2, Intel Pentium 4 1.3 GHz or faster recommended)

Application: DirectX 9.0c or later (This product is based on DirectX technology. It is necessary to have DirectX installed.)

Windows Media Player 7.0 or later
Macromedia Flash Player 6.0 or later

Sound system: 16 bit stereo sound card and stereo speakers

Memory: 64 MB or more

Hard disk: Available memory required for installation: 500 MB or more
Available free hard disk space recommended: 6 GB or more (depending on the size of the image files edited)

Display: 4 MB VRAM video card, Minimum 800 × 600 dots, High Color (16 bit color, 65,000 colors), DirectDraw display driver capability (This product will not operate correctly at less than 800 × 600 dots, or 256 colors or less.)

Others: USB port (This must be provided as standard), DV Interface (IEEE1394, i.LINK) (to connect via an i.LINK cable), disc drive (You need a CD-R drive to create a video CD. For the compatible drive, visit the following URL: <http://www.ppackage.com/>)

■ For Macintosh users

When using ImageMixer VCD2

OS: Mac OS X (v10.1.5 or later)

CPU: iMac, eMac, iBook, PowerBook, Power Mac G3/G4/G5 series

Memory: 128 MB or more

Hard disk: Available memory required for installation: 250 MB or more
Available free hard disk space recommended: 4 GB or more (depending on the size of the image files edited)

Display: Minimum 1,024 × 768 dots, 32,000 colors (This product will not operate correctly at 1,024 × 768 dots or less, or 256 colors or less.)

Application: QuickTime 4 or later (QuickTime 5 recommended)

Other: Disc drive

Before referring to the “First Step Guide” on your computer (Continued)

- When you connect your camcorder to a Macintosh computer using a USB cable, you cannot copy pictures recorded on a tape to the computer. To copy recordings from a tape, connect your camcorder to the computer with an i.LINK cable and use the standard software in the OS.

Installing the software and “First Step Guide” on a computer

You need to install the software etc., with the supplied CD-ROM on your computer **before connecting your camcorder** and your computer. Once installed, no further installation will be necessary. The software to be used varies depending on the computer's operating system you are using. Windows computer: Picture Package (including ImageMixer VCD2) Macintosh computer: ImageMixer VCD2 For the details on the software, refer to “First Step Guide.”

Installing on a Windows computer

Log on as Administrators for installation for Windows 2000/Windows XP.

1 Confirm that your camcorder is not connected to the computer.

2 Turn on the computer.

Close all applications running on the computer before installing the software.

3 Place the supplied CD-ROM in the disc drive of your computer.

The installation screen appears.



The software version of Picture Package is displayed as “1.5.”

If the screen does not appear

- ① Double-click [My Computer].
 - ② Double-click [PICTUREPACKAGE] (Disc drive).*
- * Drive names (such as (E:)) may vary depending on the computer.

4 Click [Install].



The software version of Picture Package is displayed as “1.5.”

Depending on the computer’s operating system, a message may appear notifying you that “First Step Guide” cannot be installed automatically with the InstallShield Wizard. In such a case, manually copy “First Step Guide” to your computer according to the message instructions.

5 Select the language for the application to be installed, then click [Next].

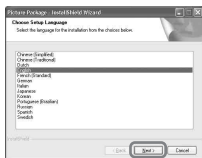

6 Click [Next].

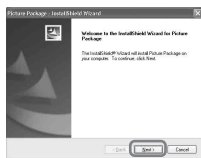

7 Read [License Agreement], check [I accept the terms of the license agreement] if you agree, then click [Next].



The software version of Picture Package is displayed as “1.5.”

8 Select where to save the software, then click [Next].



9 Click [Install] on the [Ready to Install the Program] screen.

The installation of Picture Package starts.



10 Click [Next] to install the “First Step Guide.”

Depending on the computer, this screen may not be displayed. In such a case, skip to step 11.

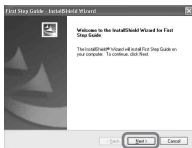

11 Click [Next], then follow the on-screen instructions to install ImageMixer VCD2.



12 If the [Installing Microsoft(R) DirectX(R)] screen is displayed, follow the steps below to install DirectX 9.0c. If not, skip to step 13.

① Read [License Agreement], then click [Next].



② Click [Next].



③ Click [Finish].



13 Make sure [Yes, I want to restart my computer now.] is checked, then click [Finish].



The computer turns off once, then starts up again automatically (Restart). The short-cut icons for [Picture Package Menu] and [Picture Package destination folder] (and “First Step Guide,” if installed in step 10) appear on the desktop.



14 Remove the CD-ROM from the disc drive of your computer.

- For details on connecting your camcorder and computer, see “First Step Guide” on the supplied CD-ROM (p. 64).
- If you have any questions about Picture Package, contact information is listed on page 64.

Installing on a Macintosh computer

1 Confirm that your camcorder is not connected to the computer.

2 Turn on the computer.

Close all applications running on the computer before installing the software.

3 Place the supplied CD-ROM in the disc drive of your computer.

4 Double-click CD-ROM icon.

5 Copy “FirstStepGuide.pdf,” stored in the desired language in the [FirstStepGuide] folder, to your computer.

6 Copy [IMXINST.SIT] in the [MAC] folder of the CD-ROM to a folder of your choice.

7 Double-click [IMXINST.SIT] in the folder it was copied to.

8 Double-click the unzipped [ImageMixerVCD2_Install].

9 When the user acceptance screen is displayed, enter your name and password.

The installation of ImageMixer VCD2 starts.

- For details on connecting your camcorder and computer, see “First Step Guide” on the supplied CD-ROM (p. 64).
- For details on how to use ImageMixer VCD2, refer to software’s on-line help.

Viewing “First Step Guide”

Displaying “First Step Guide”

Starting up on a Windows computer

Viewing with Microsoft Internet Explorer Ver.6.0 or later is recommended. Double-click the  icon on the desktop.



You can also start up [First Step Guide] by selecting [Start], [Programs] ([All Programs] for Windows XP), [Picture Package], and [First Step Guide].

- To view “First Step Guide” in HTML without using automatic installation, copy the desired language folder from the [FirstStepGuide] folder on the CD-ROM, and then double-click “index.html.”
- Refer to “FirstStepGuide.pdf” located in your desired language folder in the following cases:
 - When printing “First Step Guide”
 - When “First Step Guide” is not displayed correctly due to the browser setting even in recommended environment.
 - When the HTML version of “First Step Guide” is not installed automatically.

Starting up on a Macintosh computer

Double-click “FirstStepGuide.pdf.”



To view the PDF, Adobe Reader is needed. If it is not installed on your computer, you can download it from the Adobe Systems web page:
<http://www.adobe.com/>

For inquires about this software

Pixela User Support Center

Pixela Home Page

Picture Package:

<http://www.ppackage.com/>

ImageMixer VCD2:

<http://www.ImageMixer.com/>

– North America (Los Angeles) Telephone:

(Toll-Free) +1-800-458-4029

+1-213-341-0163

– Europe (U.K.) Telephone:

(Toll-Free) UK, Germany, France and

Spain:

+800-1532-4865

Other countries:

+44-1489-564-764

– Asia (Philippines) Telephone:

+63-2-438-0090

On Copyrights

Music works, sound recording or other third party musical contents you may acquire from CDs, the Internet or other sources (the “Music Contents”) are the copyrighted work of the respective owners thereof and are protected by copyright laws and other applicable laws of each country/region. Except to the extent expressly permitted by applicable laws, you are not permitted to use (including, without limitation, copying, modifying, reproducing, uploading, transmitting or placing to the external network accessible to the public, transferring, distributing, lending, licensing, selling and publishing) any of the Music Contents without obtaining authorization or approval of the respective owners thereof. License of Picture Package by Sony Corporation would not be construed as conferring to you by implication, estoppel or otherwise, any license or right to use the Music Contents.

Creating a DVD (Direct Access to “Click to DVD”)

You can create a DVD from a tape with a Sony VAIO series computer* preinstalled with “Click to DVD Ver.1.2” (Sony original software) or later via an i.LINK cable. The picture is automatically copied and written to a DVD.

The following procedures describe how to create a DVD from a recorded tape. For details on system and operation requirements, and “Click to DVD,” visit the following URL:

- Europe
<http://www.vaio-link.com/>
- USA
<http://cisddb.sel.sony.com/perl/select-p-n.pl>
- Asia Pacific Regional
<http://www.css.ap.sony.com/>
- Korea
<http://scs.sony.co.kr/>
- Taiwan
<http://vaio-online.sony.com/tw/vaio/>
- China
<http://www.sonystyle.com.cn/vaio/>
- Thailand
<http://www.sony.co.th/vaio/index.html>
- Latin America
<http://www.sony-latin.com/vaio/info/index.jsp>

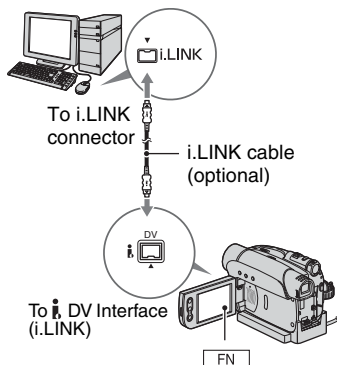

- You can only use an i.LINK cable for this operation. You cannot use a USB cable.
- For DCR-HC35E:
Do not insert/eject the cassette while your camcorder is on the Handycam Station.
This may cause a malfunction.
- * Note that you need a computer equipped with a DVD drive that can write DVDs.

Using the Direct Access to “Click to DVD” function for the first time

The Direct Access to “Click to DVD” function enables you to copy pictures recorded on a tape to a DVD easily if your camcorder is connected to a computer. Before operating the Direct Access to “Click to DVD” function, follow the steps below to start “Click to DVD Automatic Mode Launcher.”

- ① Turn on the computer.
 - ② Click the start menu, then select [All Programs].
 - ③ Select [Click to DVD] from the programs displayed, then click [Click to DVD Automatic Mode Launcher].
[Click to DVD Automatic Mode Launcher] starts up.
- After you start up [Click to DVD Automatic Mode Launcher] once, from then on it starts up automatically when you turn on your computer.
 - [Click to DVD Automatic Mode Launcher] is set up for each Windows XP user.

1 Turn on the computer.

Close all applications running with an i.LINK.

2 Prepare the power source for the camcorder.

Use the supplied AC Adaptor as the power source since it takes a few hours to create a DVD.

3 Slide the POWER switch repeatedly to turn on the PLAY/EDIT lamp.

4 Insert a recorded cassette into your camcorder.

5 Connect your camcorder (DCR-HC23E/HC24E/HC26E) or the Handycam Station (DCR-HC35E) to a computer via an i.LINK cable (p. 65).

- When you connect your camcorder to a computer, make sure you insert the connector in the correct way. If you insert the connector forcibly, damage may occur and cause camcorder malfunction.
- For details, see “First Step Guide” (p. 64).

6 Touch [FN] → [PAGE2] → [BURN DVD] → [OK].

“Click to DVD” starts up and the on-screen instructions appear on your computer.

7 Place a writable DVD in the disc drive of the computer.

8 Touch [EXEC] on the screen of your camcorder.

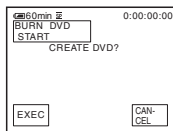

The status of the operation on your computer is displayed on the LCD screen of your camcorder.

[CAPTURING]: The picture recorded on the tape is being copied to the computer.

[CONVERTING]: The picture is being converted to the MPEG2 format.

[WRITING]: The picture is being written onto the DVD.

- If you use a DVD-RW/+RW which has other data stored on it, the message [This is a recorded disc. Delete and overwrite?] appears on the LCD screen of your camcorder. When you touch [EXEC], the existing data is erased and new data is written.

9 Touch [↵ END] to finish creating a DVD.

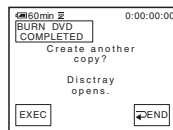

The disc tray comes out automatically. To create another DVD with the same content, touch [EXEC].

The disc tray comes out. Place a new writable DVD in the disc drive. Then, repeat step 8 and 9.

To cancel the operation

Touch [CANCEL] on the LCD screen on your camcorder.

- You cannot cancel the operation after [Finalizing DVD.] is displayed on the LCD screen of your camcorder.
- Do not disconnect the i.LINK cable or set the POWER switch to another mode on your camcorder until the picture is completely copied to the computer.
- When [CONVERTING] or [WRITING] is displayed on the screen, capturing of pictures has already finished. Even if you disconnect the i.LINK cable or turn off the camcorder at this stage, DVD creation will continue on your computer.
- If any of the following occurs, copying of the picture is canceled. A DVD containing the data up to the point the operation was canceled is created. Refer to the help files of “Click to DVD” for details.
 - The tape contains a 10-second blank portion.
 - The tape data contains a date before the date of later images.
 - Both normal and wide pictures are recorded on the same tape (Only for “Click to DVD” older than Ver.2.2).
- You cannot operate [BURN DVD] in the following situations:
 - While a tape is running.
 - When “Click to DVD” is started up from the computer.

Troubleshooting

If you run into any problems using your camcorder, use the following table to troubleshoot the problem. If the problem persists, disconnect the power source and contact your Sony dealer.

Overall operations/Easy Handycam

The power does not turn on.

- Attach a charged battery pack to the camcorder (p. 9).
- Use the AC Adaptor to connect to a wall socket (p. 9).
- For DCR-HC35E:
Insert your camcorder into the Handycam Station correctly (p. 10).

The camcorder does not operate even when the power is set to on.

- Disconnect the AC Adaptor from the wall socket or remove the battery pack, then reconnect it after about 1 minute.
- Press the RESET button (p. 25) using a sharp-pointed object. (If you press the RESET button, all settings are reset.)

Buttons do not work.

- During Easy Handycam operation, not all buttons are functional (p. 21).

You cannot turn Easy Handycam operation on or off.

- During recording or communicating with another device via USB cable, you cannot turn Easy Handycam operation on or off.

Settings change during Easy Handycam operation.

- During Easy Handycam operation, the settings of the functions that are not displayed on the screen return to their defaults. Previously made settings are restored when you cancel the Easy Handycam operation (p. 20, 43).

[DEMO MODE] does not start.

- You cannot view the demonstration together with NightShot plus (p. 24).
- Eject the cassette from your camcorder (p. 19).

The camcorder gets warm.

- The camcorder may get warmer while you use it. This is not a malfunction.

Batteries/Power sources

The power abruptly turns off.

- When approximately 5 minutes have elapsed while you do not operate your camcorder, the camcorder is automatically turned off (A.SHUT OFF). Change the setting of [A.SHUT OFF] (p. 50), or turn on the power again (p. 14), or use the AC Adaptor.
- Charge the battery pack (p. 9).

The CHG (charge) lamp does not light while the battery pack is being charged.

- Slide the POWER switch to OFF(CHG) (p. 9).
- Attach the battery pack to the camcorder correctly (p. 9).
- Connect the mains lead to the wall socket properly (p. 9).
- The battery charge is completed (p. 11).
- For DCR-HC35E:
Insert your camcorder into the Handycam Station correctly (p. 10).

The CHG (charge) lamp flashes while the battery pack is being charged.

- Attach the battery pack to the camcorder correctly (p. 9). If the problem persists, disconnect the AC Adaptor from the wall socket and contact your Sony dealer. The battery pack may be worn-out.

The power turns off frequently although the remaining battery time indicator indicates that the battery pack has enough power to operate.

- A problem has occurred in the remaining battery time indicator, or the battery pack has not been charged enough. Fully charge the battery again to correct the indication (p. 9).

The remaining battery time indicator does not indicate the correct time.

- Ambient temperature is too high or too low, or the battery pack has not been charged enough. This is not a malfunction.
- Fully charge the battery again. If the problem persists, the battery may be worn-out. Replace it with a new one (p. 9, 84).
- The indicated time may not be correct in certain circumstances. For example, when you open or close the LCD panel, it takes about 1 minute to display the correct remaining battery time.

The battery pack discharges too quickly.

- Ambient temperature is too high or too low, or the battery pack has not been charged enough. This is not a malfunction.
- Fully charge the battery again. If the problem persists, the battery may be worn-out. Replace it with a new one (p. 9, 84).

A problem occurs when the camcorder is connected to the AC Adaptor.

- Turn off the power, and disconnect the AC Adaptor from the wall socket. Then, connect it again.

LCD screen/viewfinder**A rippling effect appears on the LCD screen when you touch it.**

- This is not a malfunction. Do not press hard on the LCD screen.

Troubleshooting (Continued)

An unknown picture appears on the LCD screen or viewfinder.

- The camcorder is in [DEMO MODE] (p. 49). Touch the LCD screen or insert a cassette to cancel [DEMO MODE].
-

An unknown indicator appears on the screen.

- A warning indicator or message appears on the screen (p. 80).
-

The picture remains on the LCD screen.

- This occurs if you disconnect the DC plug from your camcorder or remove the battery pack without turning off the power first. This is not a malfunction.
-

The buttons do not appear on the touch panel.

- Touch the LCD screen lightly.
 - Press DISP/BATT INFO on your camcorder (or DISPLAY on the Remote Commander supplied with the DCR-HC24E/HC35E) (p. 16, 30).
-

The buttons on the touch panel do not work correctly or do not work at all.

- Adjust the screen ([CALIBRATION]) (p. 88).
-

The picture in the viewfinder is not clear.

- Move the viewfinder lens adjustment lever until the picture appears clearly (p. 15).
-

The picture in the viewfinder has disappeared.

- Close the LCD panel. The picture is not displayed in the viewfinder when the LCD panel is open (p. 15).
-

Dots in lines appear on the LCD screen.

- This is not a malfunction. These dots are not recorded.
-

Cassette tapes

The cassette cannot be ejected from the compartment.

- Make sure the power source (battery pack or AC Adaptor) is connected correctly (p. 9).
 - Remove the battery pack from the camcorder, then attach it again (p. 11).
 - Attach a charged battery pack to the camcorder (p. 9).
 - Moisture condensation has occurred inside the camcorder (p. 87).
-

The Cassette Memory indicator or title display does not appear while using a cassette with Cassette Memory.

- This camcorder does not support Cassette Memory, so the indicator does not appear.

The remaining tape indicator is not displayed.

- Set [REMAIN] to [ON] to always display the remaining tape indicator (p. 49).

The cassette is noisier during rewinding or fast-forwarding.

- When using the AC Adaptor, rewind/fast forward speed increases (compared with battery operation) and therefore increases noise. This is not a malfunction.

Recording

Refer also to “Adjusting the image during recording” (p. 72).

The tape does not start when you press REC START/STOP.

- Slide the POWER switch repeatedly to turn on the CAMERA lamp (p. 22).
- The tape has reached the end. Rewind it, or insert a new cassette.
- Set the write-protect tab to REC or insert a new cassette (p. 84).
- The tape is stuck to the drum due to moisture condensation. Remove the cassette and leave your camcorder for at least 1 hour, then re-insert the cassette (p. 87).

You cannot record a smooth transition on a tape from the last recorded scene to the next.

- Perform END SEARCH (p. 28).
- Do not remove the cassette. (The picture will be recorded continuously without a break even when you turn the power off.)
- Do not record pictures in SP mode and LP mode on the same tape.
- Avoid stopping then recording a movie in the LP mode.

The shutter sound is not heard when you record a still image.

- Set [BEEP] to [ON] (p. 50).

[END SCH] does not work.

- Do not eject the cassette after recording (p. 28).
- There is nothing recorded on the cassette.

[END SCH] does not work correctly.

- There is a blank section between recorded sections of the tape. This is not a malfunction.

Adjusting the image during recording

Refer also to “Menu” (p. 74).

The auto focus does not function.

- Set [FOCUS] to [↔ AUTO] (p. 38).
- The recording conditions are not suitable for auto focus. Adjust the focus manually (p. 38).

[STEADYSHOT] does not function.

- Set [STEADYSHOT] to [ON] (p. 46).

The BACK LIGHT function does not function.

- In the following settings, the BACK LIGHT function is canceled.
 - [MANUAL] of [EXPOSURE]
 - [SPOT METER]
- The BACK LIGHT function does not work during Easy Handycam operation (p. 21).

A vertical band appears when recording candlelight or electric light in the dark.

- This occurs when the contrast between the subject and the background is too high. This is not a malfunction.

A vertical band appears when recording a bright subject.

- This phenomenon is called the smear effect. This is not a malfunction.

The color of the picture is not correctly displayed.

- Deactivate the NightShot plus function (p. 24).

The screen picture is bright, and the subject does not appear on the screen.

- Deactivate the NightShot plus function (p. 24), or cancel the BACK LIGHT function (p. 24).

The picture appears too bright, or flickering or changes in color occurs.

- These anomalies may occur when recording pictures under the discharge tube, such as a fluorescent lamp, sodium lamp, or mercury lamp, with [PORTRAIT] or [SPORTS]. This is not a malfunction. Cancel [PROGRAM AE] to reduce the anomaly (p. 44).

Black bands appear when you record a TV screen or computer screen.

- Set [STEADYSHOT] to [OFF] (p. 46).

Playback

You cannot play back tape.

- Slide the POWER switch repeatedly to turn on the PLAY/EDIT lamp.
- Rewind the tape (p. 23).

Horizontal lines appear on the picture. The displayed pictures are not clear or do not appear.

- Clean the head using the cleaning cassette (optional) (p. 88).

No sound or only a low sound is heard.

- Set [HiFi SOUND] to [STEREO] (p. 47).
- Turn up the volume (p. 23).
- Adjust [AUDIO MIX] from the [ST2] (additional sound) side until the sound is heard appropriately (p. 56).
- If you are using an S VIDEO plug, make sure the red and white plugs of the A/V connecting cable are also connected (p. 33).

The sound breaks off.

- Clean the head using the cleaning cassette (optional) (p. 88).

“---” is displayed on the screen.

- The tape you are playing was recorded without setting the date and time.
- A blank section on the tape is being played.
- The data code on a tape with a scratch or noise cannot be read.

Noises appear and **NTSC** is displayed on the screen.

- The tape was recorded in a TV color system other than that of your camcorder (PAL). This is not a malfunction (p. 83).

4ch-12b is displayed on the screen.

- The tape you are playing was recorded on another device with a 4ch microphone (4CH MIC REC). Your camcorder is not compatible with 4ch microphone recording.

Date search does not work correctly. (DCR-HC24E/HC35E)

- Be sure to record more than 2 minutes after the date changed. If one day's recording is too short, your camcorder may not accurately find the point where the recording date changes.
- There is a blank section in the beginning or between recorded sections of the tape. This is not a malfunction.

Remote Commander (DCR-HC24E/HC35E)

The supplied Remote Commander does not function.

- Set [COMMANDER] to [ON] (p. 50).
- Remove any obstructions between the Remote Commander and the remote sensor.
- Keep strong light sources, such as sunlight or overhead lighting, away from the remote sensor, otherwise the Remote Commander may not function properly.
- Insert a fresh battery in the compartment with its +/- terminals matching those of the compartment (p. 89).
- Remove the conversion lens (optional) as the remote sensor may be obstructed by it.

Another VCR malfunctions when you use the supplied Remote Commander.

- Select a commander mode other than VTR 2 for your VCR.
- Cover the sensor of your VCR with black paper.

Menu

Menu items are grayed out.

- You cannot select grayed items in the current recording/playback situation.

You cannot use [SPOT FOCUS].

- You cannot use [SPOT FOCUS] together with [PROGRAM AE].

You cannot use [SPOT METER].

- You cannot use [SPOT METER] together with NightShot plus.
- If you set [PROGRAM AE], [SPOT METER] is automatically set to [↩ AUTO].

You cannot use [FADER].

- You cannot use [FADER] together with [SELF TIMER].

You cannot use [EXPOSURE].

- You cannot use [EXPOSURE] together with NightShot plus.
- If you set [PROGRAM AE], [EXPOSURE] is automatically set to [↩ AUTO].

You cannot use [WHT BAL].

- You cannot use [WHT BAL] together with NightShot plus.

You cannot use [PROGRAM AE].

- You cannot use [PROGRAM AE] together with NightShot plus.

Dubbing/Editing/Connecting to other devices

Pictures output from the camcorder do not appear on the screen of the connected device. (DCR-HC35E)

- When attaching the camcorder to the Handycam Station, close the DC IN jack cover on the camcorder, and then fully insert the camcorder into the Handycam Station in the correct way securely (p. 10).

Time code and other information appear on the display of the connected device.

- Set [DISP OUT] to [LCD] while connected with an A/V connecting cable (p. 50).

You cannot dub correctly using the A/V connecting cable.

- The A/V connecting cable is not connected properly. Make sure that the A/V connecting cable is connected to the input jack of another device for dubbing a picture from your camcorder (p. 51).

New sound added to a recorded tape is not heard.

- Adjust [AUDIO MIX] from the [ST1] (original sound) side until the sound is heard appropriately (p. 56).

Pictures from connected devices are not displayed correctly.

- The input signal is not PAL (p. 83).

The picture gets disturbed or dark, or the sounds get distorted. (DCR-HC35E)

- A/V connecting cables are connected to both your camcorder and the Handycam Station. Disconnect one of the A/V connecting cables.

Connecting to a computer

The computer does not recognize your camcorder.

- Disconnect the cable from the computer and camcorder, then connect it again securely.
- Disconnect USB devices other than the keyboard, the mouse, and the camcorder from the  (USB) jack on the computer.
- Disconnect the cable from the computer and camcorder, restart the computer, then connect them again correctly.
- For DCR-HC35E:
Insert your camcorder into the Handycam Station correctly (p. 10).

An error message appears when you place the supplied CD-ROM in your computer.

- Set the computer display as follows:
 - Windows: 800 × 600 dots or more, High Color (16 bits, 65,000 colors) or more
 - Macintosh: 1,024 × 768 dots or more, 32,000 colors or more
-

You cannot view the video your camcorder is seeing on the computer.

USB **i.LINK**

- Disconnect the cable from the computer, turn on the camcorder, then connect it again.
 - Slide the POWER switch repeatedly to turn on the CAMERA lamp on your camcorder, and set [USB STREAM] to [ON] (p. 49). (Only when connected to the Windows computer with the USB cable)
-

You cannot view the video recorded on a tape on the computer. **USB** **i.LINK**

- Disconnect the cable from the computer, then connect it again.
 - Slide the POWER switch repeatedly to turn on the PLAY/EDIT lamp on your camcorder and set [USB STREAM] to [ON] (p. 49). (Only when connected to the Windows computer with the USB cable)
-

You cannot view the video recorded on a tape on the Macintosh computer. **USB**

- When you connect your camcorder to a Macintosh computer using a USB cable, you cannot copy pictures recorded on a tape to the computer. To copy recordings from a tape, connect your camcorder to the computer with an i.LINK cable and use the standard software in the OS.
-

The image on tape does not appear on the screen of the Windows computer during USB Streaming. **USB**

- The USB driver has been registered incorrectly as the computer was connected to your camcorder before the installation of the USB driver was completed. Follow the procedure below to install the USB driver correctly.

■ For Windows Me

- 1 Check that your camcorder is connected to a computer.
- 2 Right-click [My Computer], then click [Properties].
The [System Properties] screen appears.
- 3 Click the [Device Manager] tab.
- 4 If the devices below are already installed, right-click them, then click [Remove] to delete them.
 - [USB Audio Device] in the [Sound, video and game controllers] folder
 - [USB Device] in the [Other devices] folder
 - [USB Composite Device] in the [Universal Serial Bus Controller] folder
- 5 When the [Confirm Device Removal] screen appears, click [OK].
- 6 Turn off the power of your camcorder, disconnect the USB cable, then restart the computer.

- 7 Place the supplied CD-ROM in the disc drive of your computer.
- 8 Follow the steps below and try to install the USB driver again.
 - 1 Double-click [My Computer].
 - 2 Right-click [PICTUREPACKAGE] (Disc drive)*.

* Drive names (such as (E:)) may vary depending on the computer.

 - 3 Click [Open].
 - 4 Double-click [Driver].
 - 5 Double-click [Setup.exe].
 - Deleting anything other than [USB Audio Device], [USB Device] and [USB Composite Device] may cause a malfunction of your computer.

■ For Windows 2000

Log on as Administrator.

- 1 Check that your camcorder is connected to a computer.
- 2 Right-click [My Computer], then click [Properties].
The [System Properties] screen appears.
- 3 Click the [Hardware] tab → [Device Manager] → [View] → [Devices by type].
- 4 If the devices below are already installed, right-click them, then click [Uninstall] to delete them.
 - [USB Composite Device] in the [Universal Serial Bus Controller] folder
 - [USB Audio Device] in the [Sound, video and game controller] folder
 - [Composite USB Device] in the [Other devices] folder
- 5 When the [Confirm Device Removal] screen appears, click [OK].
- 6 Turn off the power of your camcorder, disconnect the USB cable, then restart the computer.
- 7 Place the supplied CD-ROM in the disc drive of your computer.
- 8 Follow the steps below and try to install the USB driver again.
 - 1 Double-click [My Computer].
 - 2 Right-click [PICTUREPACKAGE] (Disc drive)*.

* Drive names (such as (E:)) may vary depending on the computer.

 - 3 Click [Open].
 - 4 Double-click [Driver].
 - 5 Double-click [Setup.exe].
 - Deleting anything other than [USB Composite Device], [USB Audio Device] and [Composite USB Device] may cause a malfunction of your computer.

■ For Windows XP

Log on as Administrator.

- 1 Check that your camcorder is connected to a computer.
- 2 Click [Start].
- 3 Right-click [My Computer], then click [Properties].
The [System Properties] screen appears.

Troubleshooting (Continued)

- 4 Click the [Hardware] tab → [Device Manager] → [View] → [Devices by type].
- 5 If the devices below are already installed, right-click them, then click [Uninstall] to delete them.
 - [USB Composite Device] in the [Universal Serial Bus Controller] folder
 - [USB Audio Device] in the [Sound, video and game controller] folder
 - [USB Device] in the [Other devices] folder
- 6 When the [Confirm Device Removal] screen appears, click [OK].
- 7 Turn off the power of your camcorder, disconnect the USB cable, then restart the computer.
- 8 Place the supplied CD-ROM in the disc drive of your computer.
- 9 Follow the steps below and try to install the USB driver again.
 - 1 Double-click [My Computer].
 - 2 Right-click [PICTUREPACKAGE] (Disc drive)*.
 - * Drive names (such as (E:)) may vary depending on the computer.
 - 3 Click [Open].
 - 4 Double-click [Driver].
 - 5 Double-click [Setup.exe].
 - Deleting anything other than [USB Composite Device], [USB Audio Device] and [USB Device] may cause a malfunction of your computer.

[Cannot start Easy Handycam with USB connected.] appears on the screen of your camcorder. [USB](#)

- You cannot start the Easy Handycam settings while the USB cable is connected. Disconnect the USB cable from your camcorder first.

There is no sound when the camcorder is connected to the Windows computer via a USB cable. [USB](#)

- Change the settings for your computer environment as described in the following procedures:
 - 1 Select [Start] → [Programs]([All Programs] for Windows XP) → [Picture Package] → [Handycam Tools] → [USB Streaming Tool].
 - 2 Select another device on the [Select audio device] screen.
 - 3 Follow the on-screen instructions, click [Next], then click [Done].

The movie is not smooth during USB Streaming. [USB](#)

- Change the settings as described in the following procedures:
 - 1 Select [Start] → [Programs]([All Programs] for Windows XP) → [Picture Package] → [Handycam Tools] → [USB Streaming Tool].
 - 2 Adjust the slider in the (-) direction on [Select video quality].
 - 3 Follow the on-screen instructions, click [Next], then click [Done].

Picture Package does not function correctly.

- Close Picture Package, then restart the computer.

An error message appears while operating Picture Package.

- Close Picture Package first, then slide the POWER switch on your camcorder to turn on another lamp.

The CD-R drive is not recognized or data cannot be written on the CD-R in Picture Package Auto Video, Producer, CD Backup, or VCD Maker.

- For compatible drives, visit the following URL:
<http://www.ppackage.com/>

“First Step Guide” is not displayed correctly.

- Follow the procedure below and refer to “First Step Guide” (FirstStepGuide.pdf).
 - 1 Place the supplied CD-ROM in the disc drive of your computer.
 - 2 Double-click [My Computer].
 - 3 Right-click [PICTUREPACKAGE] (Disc drive)*.
 - * Drive names (such as (E:)) may vary depending on the computer.
 - 4 Click [Explorer].
 - 5 Double-click [FirstStepGuide].
 - 6 Double-click the desired language folder.
 - 7 Double-click “FirstStepGuide.pdf.”

Warning indicators and messages

Self-diagnosis display/Warning indicators

If indicators appear on the LCD screen or in the viewfinder, check the following. Some symptoms you can fix by yourself. If the problem persists even after you have tried a couple of times, contact your Sony dealer or local authorized Sony service facility.

C:(or E:) □□:□□ (Self-diagnosis display)

C:04:□□

- The battery pack is not an “InfoLITHIUM” battery pack. Use an “InfoLITHIUM” battery pack (p. 84).
- Connect the DC plug of the AC Adaptor to the DC IN jack of your camcorder securely (p. 9).

C:21:□□

- Moisture condensation has occurred. Remove the cassette and leave your camcorder for at least 1 hour, then re-insert the cassette (p. 87).

C:22:□□

- Clean the head using a cleaning cassette (optional) (p. 88).

C:31:□□ / C:32:□□

- Symptoms that are not described above have occurred. Remove and insert the cassette, then operate your camcorder again. Do not perform this procedure if moisture condensation has occurred (p. 87).
- Remove the power source. Reconnect it and operate your camcorder again.
- Change the cassette. Press RESET (p. 25), and operate your camcorder again.

E:61:□□ / E:62:□□

- Contact your Sony dealer or local authorized Sony service facility. Inform them of the 5-digit code, which starts from “E.”

(Battery level warning)

- The battery pack is nearly used up.
- Depending on the operating environment, or battery conditions,  may flash, even if there are approximately 5 to 10 minutes remaining.

(Moisture condensation warning)*

- Eject the cassette, remove the power source, and then leave it for about 1 hour with the cassette lid open (p. 87).

(Warning indicators pertaining to the tape)

Slow flashing:

- There is less than 5 minutes remaining on the tape.
- No cassette is inserted.*
- The write-protect tab on the cassette is set to lock (p. 84).*

Fast flashing:

- The tape has run out.*

(Eject cassette warning)*

Slow flashing:

- The write-protect tab on the cassette is set to lock (p. 84).

Fast flashing:

- Moisture condensation has occurred (p. 87).
- The self-diagnosis display code is displayed (p. 80).

* You hear a melody when the warning indicators appear on the screen (p. 50).

Description of warning messages

If messages appear on the screen, follow the instructions.

■ Battery/Power

Use the “InfoLITHIUM” battery pack. (p. 84)

Battery level is low.

- Change the battery (p. 9, 84).

Old battery. Use a new one. (p. 84)

▲ Re-attach the power source. (p. 9)

Use new AC adapter or reinsert. (p. 9)

■ Moisture condensation

☒▲ Moisture condensation. Eject the cassette (p. 87)

☒ Moisture condensation. Turn off for 1H. (p. 87)

■ Cassette/Tape

☒☒ Insert a cassette. (p. 19)

▲ Reinsert the cassette. (p. 19)

- Check if the cassette is damaged.

☒☒▲ The tape is locked - check the tab. (p. 84)

☒☒ The tape has reached the end. (p. 19, 23)

- Rewind or change the tape.

■ Others

Cannot record due to copyright protection. (p. 83)

Cannot add audio. Disconnect the i.LINK cable. (p. 55)

Not recorded in SP mode. Cannot add audio. (p. 55)

Not recorded in 12-bit audio. Cannot add audio. (p. 55)

Cannot add audio on the blank portion of a tape. (p. 55)

Cannot add audio. (p. 55)

- You cannot add sound to a tape recorded on other devices by 4CH MIC REC.

☒☒ Dirty video head. Use a cleaning cassette. (p. 88)

Cannot start Easy Handycam. (p. 20, 68)

Cannot cancel Easy Handycam. (p. 20, 68)

Cannot start Easy Handycam with USB connected.

- You cannot start the Easy Handycam settings while the USB cable is connected. Disconnect the USB cable from your camcorder first.

Invalid during Easy Handycam operation. (p. 21)

USB invalid during Easy Handycam

- You cannot connect the USB cable during Easy Handycam. Touch **[OK]**.
-

HDV recorded tape. Cannot playback.

- Your camcorder cannot play back this format. Play back the tape with the equipment that recorded it.
-

HDV recorded tape. Cannot add audio.

- Your camcorder does not allow you to add audio on a section of a tape recorded in HDV format (p. 55).
-

Disconnect one AV cable.

- A/V connecting cables are connected to both the camcorder and the Handycam Station. Disconnect one of them.
 - When the A/V connecting cable is connected only to your camcorder, your camcorder is not attached to the Handycam Station correctly. Attach the Handycam Station correctly.
-

Using your camcorder abroad

Power supply

You can use your camcorder in any country/region using the AC Adaptor supplied with your camcorder within the AC 100 V to 240 V, 50/60 Hz range.

On TV color systems

Your camcorder is PAL system, so its picture can only be viewed on a PAL system TV with an AUDIO/VIDEO input jack.

System	Used in
PAL	Australia, Austria, Belgium, China, Czech Republic, Denmark, Finland, Germany, Holland, Hong Kong, Hungary, Italy, Kuwait, Malaysia, New Zealand, Norway, Poland, Portugal, Singapore, Slovak Republic, Spain, Sweden, Switzerland, Thailand, United Kingdom, etc.
PAL - M	Brazil
PAL - N	Argentina, Paraguay, Uruguay.
SECAM	Bulgaria, France, Guiana, Iran, Iraq, Monaco, Russia, Ukraine, etc.
NTSC	Bahama Islands, Bolivia, Canada, Central America, Chile, Colombia, Ecuador, Guyana, Jamaica, Japan, Korea, Mexico, Peru, Surinam, Taiwan, the Philippines, the U.S.A., Venezuela, etc.

Simple setting of the clock by time difference

You can easily set the clock to local time abroad by the time difference you are in. Select [WORLD TIME] in the **[ETC]** (OTHERS) menu, then set the time difference (p. 50).

Usable cassette tapes

You can use mini DV format cassettes only. Use a cassette with the **Mini DV** mark. Your camcorder is not compatible with cassettes with Cassette Memory.

To prevent a blank section from being created on the tape

Go to the end of the recorded section using END SEARCH (p. 28) before you begin the next recording in the following cases:

- You have played back the tape.
- You have used EDIT SEARCH.

Copyright signal

■ When you play back

If the cassette you play back on your camcorder contains copyright signals, you cannot copy it to a tape in another video camera connected to your camcorder.

■ For DCR-HC26E/HC35E: When you record

You cannot record software on your camcorder that contains copyright control signals for copyright protection of software. [Cannot record due to copyright protection.] appears on the LCD screen, or on the viewfinder if you try to record such software. Your camcorder does not record copyright control signals on the tape when it records.

Notes on use

■ When not using your camcorder for a long time

Remove the cassette and store it.

Usable cassette tapes (Continued)

■ To prevent accidental erasure

Slide the write-protect tab on the cassette to set it to SAVE.

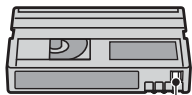

REC: The cassette can be recorded.

SAVE: The cassette cannot be recorded (write-protected).

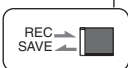

■ When labeling the cassette

Be sure to place the label only on the locations shown in the following illustration so as not to cause a malfunction of your camcorder.

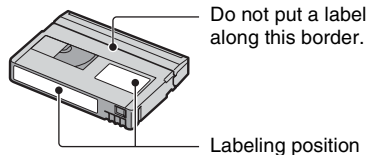

■ After using the cassette

Rewind the tape to the beginning to avoid distortion of the picture or the sound. The cassette should then be put in its case, and stored in an upright position.

■ When cleaning the gold-plated connector

Generally, clean the gold-plated connector on a cassette with a cotton-wool swab after every 10 times it has been ejected.

If the gold-plated connector on the cassette is dirty or dusty, the remaining tape indicator may not show correctly.

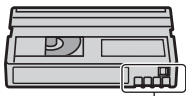

Gold-plated connector

About the “InfoLITHIUM” battery pack

This unit is compatible with an “InfoLITHIUM” battery pack (P series). Your camcorder operates only with an “InfoLITHIUM” battery pack. “InfoLITHIUM” P series battery packs have the  mark.

What is an “InfoLITHIUM” battery pack?

An “InfoLITHIUM” battery pack is a lithium-ion battery pack that has functions for communicating information related to operating conditions between your camcorder and an optional AC Adaptor/charger.

The “InfoLITHIUM” battery pack calculates the power consumption according to the operating conditions of your camcorder, and displays the remaining battery time in minutes.

To charge the battery pack

- Be sure to charge the battery pack before you start using your camcorder.
- We recommend charging the battery pack in an ambient temperature of between 10 °C to 30 °C (50 °F to 86 °F) until the CHG (charge) lamp turns off. If you charge the battery pack outside of this temperature range, you may not be able to charge it efficiently.
- When charging the battery pack while the AC Adaptor is connected to your camcorder, after charging is complete, disconnect the cable from the DC IN jack on your camcorder or remove the battery pack.

To use the battery pack effectively

- Battery pack performance decreases when the surrounding temperature is 10 °C (50 °F) or below, and the length of time you can use the battery pack becomes shorter. In that case, do one of the following to use the battery pack for a longer time.
 - Put the battery pack in a pocket to warm it up, and insert it in your camcorder right before you start taking shots.
 - Use a large capacity battery pack: NP-FP50/FP70/FP71/FP90 (optional).

- Frequent use of the LCD screen or a frequent playback, fast forward or rewind operation wears out the battery pack faster.
We recommend using a large capacity battery pack: NP-FP50/FP70/FP71/FP90 (optional).
- Be sure to set the POWER switch to OFF(CHG) when not recording or playing back on your camcorder. The battery pack is also consumed when your camcorder is in recording standby or playback pause.
- Have spare battery packs ready for two or three times the expected recording time, and make trial recordings before making the actual recording.
- Do not expose the battery pack to water. The battery pack is not water resistant.

About the remaining battery time indicator

- When the power goes off even though the remaining battery time indicator indicates that the battery pack has enough power to operate, charge the battery pack fully again. Remaining battery time will be indicated correctly. Note, however, that the battery indication will not be restored if it is used in high temperatures for a long time, or if left in a fully charged state, or when the battery pack is frequently used. Use the remaining battery time indication as a rough guide only.
- The  mark that indicates low battery flashes even if there are still 5 to 10 minutes of battery time remaining, depending on the operating conditions or ambient temperature.

About storage of the battery pack

- If the battery pack is not used for a long time, fully charge the battery pack and use it up on your camcorder once a year to maintain proper function. To store the battery pack, remove it from your camcorder and put it in a dry, cool place.
- To discharge the battery pack on your camcorder completely, set [A.SHUT OFF] to [NEVER] on the  (OTHERS) menu and leave your camcorder in tape recording standby until the power goes off (p. 50).

About battery life

- Battery capacity decreases over time and through repeated use. If decreased usage time between charges becomes significant, it is probably time to replace it with a new one.
- Each battery's life is governed by storage, operating and environmental conditions.

About i.LINK

The DV Interface on this unit is an i.LINK-compliant DV Interface. This section describes the i.LINK standard and its features.

What is i.LINK?

i.LINK is a digital serial interface for transferring digital video, digital audio, and other data to other i.LINK-compatible devices. You can also control other devices using the i.LINK.

i.LINK-compatible devices can be connected using an i.LINK cable. Possible applications are operations and data transactions with various digital AV devices.

When two or more i.LINK-compatible devices are daisy-chained with the unit, operation becomes possible from any device in the chain. Note that operation method may vary, or data transactions may not be possible, depending on specifications and characteristics of the connected devices.

- Normally, only one device can be connected to this unit with an i.LINK cable. When connecting this unit to an i.LINK-compatible device having two or more DV Interfaces, refer to the operating instructions of the device to be connected.
- i.LINK is a more familiar term for the IEEE 1394 data transport bus proposed by Sony, and is a trademark approved by many corporations.
- IEEE 1394 is an international standard standardized by the Institute of Electrical and Electronics Engineers.

About the i.LINK Baud rate

i.LINK's maximum baud rate varies according to the device. There are 3 types.

S100 (approx. 100Mbps*)

S200 (approx. 200Mbps)

S400 (approx. 400Mbps)

The baud rate is listed under "Specifications" in the operating instructions of each piece of equipment. It

is also indicated near the i.LINK interface on some devices.

The baud rate may differ from the indicated value when the unit is connected to a device with a different maximum baud rate.

* What is Mbps?

Mbps stands for "megabits per second," or the amount of data that can be sent or received in one second. For example, a baud rate of 100 Mbps means that 100 megabits of data can be sent in one second.

To use i.LINK functions on this unit

For details on how to dub when this unit is connected to other video devices having a DV Interface, see page 51, 54.

This unit can also be connected to other i.LINK (DV Interface) compatible devices made by Sony (e.g. a VAIO series personal computer) as well as to video devices. Some i.LINK compatible video devices, such as Digital Televisions, DVD, MICROMV or HDV recorders/players are not compatible with DV devices. Before connecting to other devices, be sure to confirm whether the device is compatible with a DV device or not. For details on precautions and compatible application software, refer also to the operating instructions for the device to be connected.

About the required i.LINK cable

Use the Sony i.LINK 4-pin-to-4-pin cable (during DV dubbing).

Maintenance and precautions

On use and care

- Do not use or store the camcorder and accessories in the following locations.
 - Anywhere extremely hot or cold. Never leave them exposed to temperatures above 60 °C (140 °F), such as under direct sunlight, near heaters or in a car parked in the sun. They may malfunction or become deformed.
 - Near strong magnetic fields or mechanical vibration. The camcorder may malfunction.
 - Near strong radio waves or radiation. The camcorder may not be able to record properly.
 - Near AM receivers and video equipment. Noise may occur.
 - On a sandy beach or anywhere dusty. If sand or dust gets in your camcorder, it may malfunction. Sometimes this malfunction cannot be repaired.
 - Near windows or outdoors, where the LCD screen, the viewfinder, or the lens may be exposed to direct sunlight. This damages the inside of the viewfinder or the LCD screen.
 - Anywhere very humid.
- Operate your camcorder on DC 7.2 V (battery pack) or DC 8.4 V (AC Adaptor).
- For DC or AC operation, use the accessories recommended in these operating instructions.
- Do not let your camcorder get wet, for example, from rain or sea water. If your camcorder gets wet, it may malfunction. Sometimes this malfunction cannot be repaired.
- If any solid object or liquid gets inside the casing, unplug your camcorder and have it checked by a Sony dealer before operating it any further.
- Avoid rough handling, disassembling, modifying, physical shock, or impact such as hammering, dropping or stepping on the product. Be particularly careful of the lens.
- Keep the POWER switch setting to OFF(CHG) when you are not using your camcorder.
- Do not wrap your camcorder with a towel, for example, and operate it. Doing so might cause heat to build up inside.
- When disconnecting the mains lead, pull it by the plug and not the lead.
- Do not damage the mains lead such as by placing anything heavy on it.
- Keep metal contacts clean.
- Keep the Remote Commander supplied with the DCR-HC24E/HC35E and button-type battery



out of children's reach. If the battery is accidentally swallowed, consult a doctor immediately.

- If the battery electrolytic liquid has leaked,
 - consult your local authorized Sony service facility.
 - wash off any liquid that may have contacted your skin
 - if any liquid gets in your eyes, wash with plenty of water and consult a doctor.

■ When not using your camcorder for a long time



- Periodically turn on the camcorder and play a cassette for about 3 minutes.
- Use up the battery pack completely before storing it.

Moisture condensation

If your camcorder is brought directly from a cold place to a warm place, moisture may condense inside your camcorder, on the surface of the tape, or on the lens. In this state, the tape may stick to the head drum and be damaged or your camcorder may not operate correctly. If there is moisture inside your camcorder, [  Moisture condensation. Eject the cassette] or [ Moisture condensation. Turn off for 1H.] appears. The indicator will not appear when the moisture condenses on the lens.

■ If moisture condensation has occurred

None of the functions except cassette ejection will work. Eject the cassette, turn off your camcorder, and leave it for about one hour with the cassette lid open. Your camcorder can be used again when both of the following conditions are met:

- The warning message does not appear when the power is turned on.
- Neither  or  flash when a cassette is inserted and video operation buttons are touched.

If moisture starts to condense, your camcorder sometimes cannot detect condensation. If this happens, the cassette is sometimes not ejected for 10 seconds after the cassette lid is opened. This is not a

Maintenance and precautions (Continued)

malfunction. Do not close the cassette lid until the cassette is ejected.

■ Note on moisture condensation

Moisture may condense when you bring your camcorder from a cold place into a warm place (or vice versa) or when you use your camcorder in a humid place as shown below.

- When you bring your camcorder from a ski slope into a place warmed up by a heating device.
- When you bring your camcorder from an air conditioned car or room into a hot place outside.
- When you use your camcorder after a squall or a shower.
- When you use your camcorder in a hot and humid place.

■ How to avoid moisture condensation

When you bring your camcorder from a cold place into a warm place, put your camcorder in a plastic bag and seal it tightly. Remove the bag when the air temperature inside the plastic bag has reached the surrounding temperature (after about one hour).

Video head

- If the video heads are dirty, video or sound distortion may be apparent.
- If the following problem occurs, clean the video heads for 10 seconds with the Sony DVM-12CLD cleaning cassette (optional).
 - Mosaic-pattern noise appears on the playback picture or the screen is displayed in blue.



- Playback pictures do not move.
- Playback pictures do not appear or the sound breaks off.
- [🚫📺] Dirty video head. Use a cleaning cassette.] appears on the screen during recording/playback.
- The video heads will wear after long use. If you cannot obtain a clear image even after using a cleaning cassette (optional), it might be because the video heads are worn. Please contact your

Sony dealer or local authorized Sony service facility to have the video heads replaced.

LCD screen

- Do not exert excessive pressure on the LCD screen, as it may cause damage.
- If your camcorder is used in a cold place, a residual image may appear on the LCD screen. This is not a malfunction.
- While using your camcorder, the back of the LCD screen may heat up. This is not a malfunction.

■ To clean the LCD screen

If fingerprints or dust make the LCD screen dirty, it is recommended you use a soft cloth to clean it. When you use the LCD Cleaning Kit (optional), do not apply the cleaning liquid directly to the LCD screen. Use cleaning paper moistened with the liquid.

■ On adjustment of the LCD screen (CALIBRATION)

The buttons on the touch panel may not work correctly. If this happens, follow the procedure below. It is recommended you connect your camcorder to the wall socket using the supplied AC Adaptor during the operation.

- ① Slide the POWER switch to OFF(CHG).
- ② Eject the cassette from your camcorder, then disconnect any connecting cables except the AC Adaptor from your camcorder or the Handycam Station supplied with the DCR-HC35E.
- ③ Slide the POWER switch repeatedly to turn on the PLAY/EDIT lamp while pressing DISP/BATT INFO on your camcorder, and keep pressing down DISP/BATT INFO for about 5 seconds.

- ④ Touch the “x” displayed on the screen with the corner of the “Memory Stick” or the like.

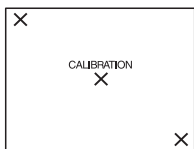

The position of the “x” changes. If you did not press the right spot, start from step ④ again.

- You cannot calibrate the LCD screen if it is rotated.

On handling the casing

- If the casing is soiled, clean the camcorder body with a soft cloth lightly moistened with water, and then wipe the casing with a dry soft cloth.
- Avoid the following to avoid damage to the finish.
 - Using chemicals such as thinner, benzene, alcohol, chemical cloths, repellent, insecticide and sunscreen.
 - Handling with above substances on your hands.
 - Leaving the casing in contact with rubber or vinyl objects for a long period of time.

About care and storage of the lens

- Wipe the surface of the lens clean with a soft cloth in the following instances:
 - When there are fingerprints on the lens surface.
 - In hot or humid locations
 - When the lens is exposed to salty air such as at the seaside.
- Store in a well-ventilated location subject to little dirt or dust.
- To prevent mold, periodically clean the lens as described above. It is recommended that you operate your camcorder about once a month to keep it in optimum state for a long time.

On charging the pre-installed rechargeable battery

Your camcorder has a pre-installed rechargeable battery to retain the date, time, and other settings even when the POWER switch is set to OFF(CHG). The pre-installed rechargeable battery is always charged while your camcorder is connected to the wall socket via the AC Adaptor or while the battery pack is attached. The rechargeable battery will be fully discharged in about **3 months** if you do not use your camcorder at all without the AC Adaptor connected or the battery pack attached. Use your camcorder after charging the pre-installed rechargeable battery.

However, even if the pre-installed rechargeable battery is not charged, the camcorder operation will not be affected as long as you are not recording the date.

■ Procedures

Connect your camcorder to a wall socket using the supplied AC Adaptor, and leave it with the POWER switch set to OFF(CHG) for more than 24 hours.

To change the battery of the Remote Commander (DCR-HC24E/HC35E)

- ① While pressing on the tab, inset your fingernail into the slit to pull out the battery case.
- ② Place a new battery with the + side facing up.
- ③ Insert the battery case back into the Remote Commander until it clicks.

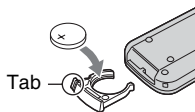

WARNING

Battery may explode if mistreated. Do not recharge, disassemble or dispose of in fire.

- A button-type lithium battery (CR2025) is used in the Remote Commander. Do not use batteries other than the CR2025.
- When the lithium battery becomes weak, the operating distance of the Remote Commander may shorten, or the Remote Commander may not function properly. In this case, replace the battery with a Sony CR2025 lithium battery. Use of another battery may present a risk of fire or explosion.

Specifications

System

Video recording system

2 rotary heads, Helical scanning system

Audio recording system

Rotary heads, PCM system

Quantization: 12 bits (Fs 32 kHz, stereo 1, stereo 2), 16 bits (Fs 48 kHz, stereo)

Video signal

PAL color, CCIR standards

Usable cassette

Mini DV cassette with the ^{Mini}**DV** mark printed

Tape speed

SP: Approx. 18.81 mm/s

LP: Approx. 12.56 mm/s

Recording/playback time

SP: 60 min (using a DVM60 cassette)

LP: 90 min (using a DVM60 cassette)

Fast forward/rewind time

Approx. 2 min 40 s (using a DVM60 cassette and rechargeable battery pack)

Approx. 1 min 45 s (using a DVM60 cassette and AC Adaptor)

Viewfinder

Electric viewfinder (color)

Image device

3.0 mm (1/6 type) CCD (Charge Coupled Device)

Gross: Approx. 800 000 pixels

Effective (movie): Approx. 400 000 pixels

Lens

DCR-HC23E:

Carl Zeiss Vario-Tessar

20 × (Optical), 640 × (Digital)

DCR-HC24E/HC26E/HC35E:

Carl Zeiss Vario-Tessar

20 × (Optical), 800 × (Digital)

Focal length

f=2.3 ~ 46 mm (3/32 ~ 1 13/16 in.)

When converted to a 35 mm still camera

In CAMERA: 44 ~ 880 mm (1 3/4 ~ 34 1/32 in.)

F1.8 ~ 3.1

Filter diameter: 25 mm (1 in.)

Color temperature

[AUTO], [ONE PUSH], [INDOOR]
(3 200 K), [OUTDOOR] (5 800 K)

Minimum illumination

5 lx (lux) (F 1.8)

0 lx (lux) (during NightShot plus
function)*¹

*¹ Objects unable to be seen due to the dark
can be shot with infrared lighting.

Input/Output connectors

Audio/Video output

10-pin connector

Video signal: 1 Vp-p, 75 Ω (ohms),
unbalanced

Luminance signal: 1 Vp-p, 75 Ω
(ohms), unbalanced

Chrominance signal: 0.3 Vp-p, 75 Ω
(ohms), unbalanced

Audio signal: 327 mV (at load
impedance 47 kΩ (kilohms)), Output
impedance with less than 2.2 kΩ
(kilohms)

USB jack (DCR-HC23E/HC24E/HC26E)

mini-B

DV input/output (DCR-HC26E)

i.LINK Interface (IEEE1394, 4-pin
connector S100)

DV output (DCR-HC23E/HC24E)

i.LINK Interface (IEEE1394, 4-pin
connector S100)

LCD screen

Picture

6.2 cm (2.5 type)

Total dot number

123 200 (560 × 220)

General

Power requirements

DC 7.2 V (battery pack)

DC 8.4 V (AC Adaptor)

Average power consumption

During camera recording using the
viewfinder 1.8 W

During camera recording using the
LCD 2.1 W

Operating temperature

0 °C to 40 °C (32 °F to 104 °F)

Storage temperature

-20 °C to +60 °C (-4 °F to +140 °F)

Dimensions (approx.)

65 × 79 × 113 mm

(2 5/8 × 3 1/8 × 4 1/2 in.) (w/h/d)

Mass (approx.)

DCR-HC23E/HC24E/HC26E:

360 g (12 oz) main unit only

420 g (14 oz) including the NP-FP30
rechargeable battery pack and DVM60
cassette.

DCR-HC35E:

370 g (13 oz) main unit only

430 g (15 oz) including the NP-FP30
rechargeable battery pack and DVM60
cassette.

Supplied accessories

See page 8.

Handycam Station DCRA-C151

Input/Output connectors (DCR-HC35E)

Audio/Video output

10-pin connector

Video signal: 1 Vp-p, 75 Ω (ohms),
unbalanced

Luminance signal: 1 Vp-p, 75 Ω
(ohms), unbalanced

Chrominance signal: 0.3 Vp-p, 75 Ω
(ohms), unbalanced

Specifications (Continued)

Audio signal: 327 mV (at load impedance 47 k Ω (kilohms)), Output impedance with less than 2.2 k Ω (kilohms)

USB jack

mini-B

DV input/output

i.LINK Interface (IEEE1394, 4-pin connector S100)

AC Adaptor AC-L25A/L25B

Power requirements

AC 100 - 240 V, 50/60 Hz

Current consumption

0.35 - 0.18 A

Power consumption

18 W

Output voltage

DC 8.4 V*²

Operating temperature

0 °C to 40 °C (32 °F to 104 °F)

Storage temperature

-20 °C to +60 °C (-4 °F to +140 °F)

Dimensions (approx.)

56 × 31 × 100 mm (2 1/4 × 1 1/4 × 4 in.)
(w/h/d) excluding the projecting parts

Mass (approx.)

190 g (6.7 oz) excluding the mains lead

*²See the label on the AC Adaptor for other specifications.

Rechargeable battery pack (NP-FP30)

Maximum output voltage

DC 8.4 V

Output voltage

DC 7.2 V

Capacity

3.6 Wh (500 mAh)

Dimensions (approx.)

31.8 × 18.5 × 45.0 mm
(1 5/16 × 3/4 × 1 13/16 in) (w/h/d)

Mass (approx.)

40 g (1.5 oz)

Operating temperature

0 °C to 40 °C (32 °F to 104 °F)

Type

Lithium ion

Design and specifications are subject to change without notice.

Types of differences

DCR-HC	23E	24E
DV Interface	OUT	OUT
Remote sensor	–	●
Handycam Station	–	–

DCR-HC	26E	35E
DV Interface	IN/OUT	IN/OUT
Remote sensor	–	●
Handycam Station	–	●

● Provided

– Not provided

On trademarks

- “InfoLITHIUM” is a trademark of Sony Corporation.
- i.LINK and  are trademarks of Sony Corporation.
- Picture Package is a trademark of Sony Corporation.
- Mini  is a trademark.
- “Handycam” and **HANDYCAM** are registered trademarks of Sony Corporation.
- Microsoft, Windows, and Windows Media are trademarks or registered trademarks of U.S. Microsoft Corporation in the U.S. and other countries.
- Windows Media Player is a trademark of Microsoft Corporation.
- iMac, iBook, eMac, Macintosh, Mac OS, PowerBook and Power Mac are trademarks of Apple Computer, Inc in the U.S. and other countries.
- QuickTime and the QuickTime logo are trademarks of Apple Computer, Inc.
- Adobe, the Adobe logo, and Adobe Acrobat are either registered trademarks or trademarks of Adobe Systems Incorporated in the United States and/or other countries.
- Roxio is a registered trademark of Roxio, Inc.
- Toast is a trademark of Roxio, Inc.
- Macromedia and Macromedia Flash Player are trademarks or registered trademarks of Macromedia, Inc. in the United States and other countries.
- Pentium is a trademark or registered trademark of Intel Corporation.

All other product names mentioned herein may be the trademarks or registered trademarks of their respective companies. Furthermore, TM and “®” are not mentioned in each case in this manual.

Index

Numeric

12BIT.....	48
16BIT.....	48
16:9 WIDE.....	46
21-pin adaptor.....	34
4:3.....	46

A

A DUB CTRL (Audio dubbing).....	56
AC Adaptor.....	9
Adjusting exposure for back light.....	24, 72
AUDIO MIX.....	56
AUDIO MODE.....	48
AUTO SHTR (Auto shutter).....	45
A.SHUT OFF (Auto shut off).....	50
A/V connecting cable.....	34, 52
A/V OUT jack.....	33, 51

B

BACK LIGHT.....	24, 72
BATT (battery) release lever	12
Battery	
Battery info.....	25
Battery pack.....	9
Charging time.....	12
Playing time.....	12
Recording time.....	12
Remaining battery.....	26
BEACH&SKI.....	44
BEEP.....	50
BLACK.....	39
BURN DVD.....	42, 65
BURN VCD.....	42
Button-type lithium battery	90
B&W.....	45

C

CALIBRATION.....	88
CAM DATA.....	41
CAMERA SET menu.....	45
Cassette.....	19, 83
Insert/Eject.....	19
Write-protect tab.....	84
Cassette compartment.....	19
CD-ROM.....	58
Charging the battery.....	9
Battery pack.....	9
Pre-installed rechargeable battery.....	89
Charging time.....	12
CHG (charge) lamp.....	10
Click to DVD.....	65
CLOCK SET.....	18
COMMANDER.....	50
Computer.....	58, 60
Connect	
Computer.....	58
TV.....	33
VCR.....	33, 51, 54

D

D ZOOM (Digital zoom).....	45
DATA CODE.....	26, 41
Date search.....	31
DATE/TIME.....	18, 26, 41
DC IN jack.....	9
DC plug.....	9
DEMO MODE.....	49, 68
DISP GUIDE (Display guide).....	16
DISP OUT (Display output).....	50
Display indicators.....	26
DISP/BATT INFO button	16, 25
Double speed Playback.....	42
Dubbing.....	51, 55

DV Interface.....	51, 54, 57, 65
-------------------	----------------

E

EASY button.....	20
Easy Handycam.....	20, 37
EDITSEARCH.....	28, 46
END SCH (END SEARCH).....	28, 71
EXPOSURE.....	40, 74

F

FADER.....	39, 74
Fireworks.....	44
First Step Guide.....	58, 64
Flexible spot meter	See SPOT METER
FN (Function) button.....	26, 36
FOCUS.....	38, 72
Frame-by-frame Playback.....	42
Full charge.....	11

G

Getting started.....	8
Grip belt.....	14

H

Handycam Station.....	10, 57
Help.....	59
HiFi SOUND.....	47
Holding the camcorder.....	14

I

Icon.....	See Display indicators
ImageMixer VCD2.....	58
Indicators.....	27
INDOOR.....	40
“InfoLITHIUM” battery pack	84
Infrared port.....	24
Initialize (Reset).....	25
Install.....	60

Insulation sheet	30
Interface connector	57
Internal stereo microphone	25
i.LINK.....	86
i.LINK cable	52, 54, 65

J

Jack	57
------------	----

L

Label	84
LANDSCAPE.....	44
LANGUAGE.....	49
LCD	50
LCD BRT (LCD bright)	41
LCD B.L. (LCD back light).....	47
LCD COLOR.....	47
LCD panel.....	15
LCD screen.....	15
LCD/VF SET menu	47
Lens cap	8, 14, 20
LETTER BOX	48
Lid.....	19
LP (Long Play)	48

M

Macintosh	59, 63
Main sound	47
Mains lead.....	9
Maintenance.....	87
MANUAL SET menu.....	44
Menu.....	36
CAMERA SET menu.....	45
LCD/VF SET menu.....	47
MANUAL SET menu	44
Menu items	43
OTHERS menu.....	50
PLAYER SET menu	47
SETUP MENU menu	49
TAPE SET menu	48

Using the menu	36
VCR SET menu	47
Mirror mode	25
Moisture condensation	87
MONOTONE.....	39
MOSAIC	45
MOSC. FADER	39
Movie	
REC MODE (Recording mode).....	48

N

NEG.ART	44
NightShot plus.....	24
NIGHTSHOT PLUS switch	24
NTSC	83
N.S.LIGHT (NightShot Light).....	46

O

ONE PUSH	40
OPEN/EJECT lever.....	19
Operation button	36
Operation confirmation beep	See BEEP
OTHERS menu	50
OUTDOOR	40

P

P EFFECT (Picture effect).....	44
PAL	73, 83
PASTEL	45
PHOTO button	22, 30
Photo scan	31
Photo search	31
Picture Package.....	58
Picture Search	23
Pixels user support center	64
Playback	23
Double speed.....	42
Frame	42

Reverse	42
Slow.....	42
PLAYER SET menu.....	47
Playing time.....	12
PORTRAIT (Soft portrait)	44
POWER switch.....	9, 14
Pre-installed rechargeable battery	89
PROGRAM AE	44, 74

R

REC CTRL (Recording control)	54
REC MODE (Recording mode).....	48
Rec review	29
REC START/STOP button	20, 22
Rechargeable battery pack	See Battery
Recording	22
Recording capacity	26
Recording time	12
REMAIN	49
Remote Commander.....	30
Remote sensor	25
RESET button.....	25
Reversal Playback	42

S

S VIDEO cable	34, 52
S VIDEO jack	34, 52
Searching for the starting point	28
SELF TIMER	41
Self-diagnosis display.....	80
SEPIA	45
Setting the date and time	18
SETUP MENU menu	49
Shoulder Belt.....	25
Skip Scan	23
Slow Playback	42

Software.....	60	Transmitter.....	30
SOLARIZE.....	45	Tripod.....	25
SP (Standard Play).....	48	TV.....	33
Speaker.....	25	TV color systems.....	83
Specifications.....	90		
SPORTS (Sports lesson).....	44	U	
SPOT FOCUS.....	38, 74	USB jack.....	57
SPOT METER		USB STREAM.....	49
(Flexible spot meter).....	38, 74	USB Streaming.....	49
SPOTLIGHT.....	44	Using abroad.....	83
SQUEEZE.....	48		
STEADYSHOT.....	46, 72	V	
STEREO.....	47	V SPD PLAY	
Sub sound.....	47	(Various speed playback).....	42
SUNSETMOON.....	44	VCR SET menu.....	47
System requirements.....	59	VF B.L.	
		(Viewfinder back light).....	47
T		Video control buttons.....	30
Tape counter.....	26	Video head.....	88
Tape photo recording.....	22	Video operation buttons.....	26
TAPE SET menu.....	48	Viewfinder.....	15
Tape.....	See Cassette	Back light.....	47
Telephoto.....	24	Viewfinder lens adjustment	
Time code.....	26	lever.....	15
Touch panel.....	16	VOL (Volume).....	23, 41
Trademark.....	93	V-OUT/LCD.....	50
		W	
		Wall socket.....	9
		Warning indicators.....	80
		Warning messages.....	81
		WHITE.....	39
		WHT BAL	
		(White balance).....	40, 74
		Wide angle.....	24
		WIDE DISP	
		(Wide display).....	48
		WIDE SEL	
		(Wide select).....	46
		Windows.....	59, 60
		WORLD TIME.....	50
		Write-protect tab.....	84
		Z	
		Zero set memory.....	30
		ZERO SET MEMORY button	
		30
		Zoom.....	24
		Zoom lever.....	24

Additional information on this product and answers to frequently asked questions can be found at our Customer Support Website.

<http://www.sony.net/>



Printed on 100% recycled paper using
VOC (Volatile Organic Compound)-free
vegetable oil based ink.

Printed in Japan

GB

